

---

The New Alchemy

# Water Pumping Windmill Book

Gary Hirshberg

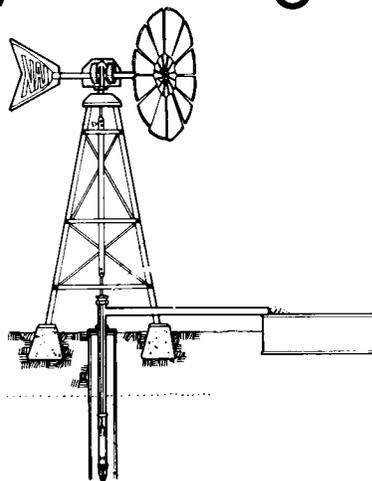

BRICK HOUSE PUBLISHING COMPANY  
Andover, Massachusetts

---

Published by Brick House Publishing Co., Inc.  
34 Essex Street  
Andover, Massachusetts

**Production Credits:**

*Editor:* Jack Howell

*Copy Editors:* Carol Higgins and Joyce Thompson

*Cover Design:* Ned Williams

*Design and Production:* Mike Fender

*Illustrations:* Maia Massion

*Typesetting:* dnh Typesetting

*Printing and Binding:* Halliday Lithograph

*Printed in the United States of America*

Copyright © 1982 by Gary Hirshberg

*All rights reserved*

*No part of this book may be reproduced in any form without the written permission of the publisher.*

**Library of Congress Cataloging in Publication Data**

Hirshberg, Gary.

The New Alchemy water pumping windmill book.

Bibliography: p. 00

1. Windmills. 2. Pumping machinery.  
3. Water-supply engineering. I. title.

TJ825.H46

621.4'5

82-4138

ISBN 0-931790-23-9 (pbk.)

AACR2

# Contents

AUTHOR'S NOTE	vii	THE NUTS AND BOLTS OF A WATER- PUMPING WINDMILL SYSTEM	106
INTRODUCTION	ix	Installing the Pump System	
A HISTORY OF THE WATER-PUMPING WINDMILL	1	Erecting the Tower and Raising the Windmill	
THE WATER-PUMPING WINDMILL SYSTEM: HOW IT WORKS	14	Maintaining Your Windmill	
The Well		THE ECONOMICS OF WATER-PUMPING WINDMILLS	123
System Components		The Sailwing versus Commercial Mills	
Transport and Storage of Water		Windmills versus Conventionally Fueled Pumps	
IS A WINDMILL FOR YOU?	40	Cost Analyses of Samuel's and Barbara's Sites	
Potential Legal Restrictions		APPENDIX	135
Assessing Your Wind Resource		BIBLIOGRAPHY	139
Determining Your Water Use		NOTES	140
Selecting the WPWS for Your Needs		ABOUT THE NEW ALCHEMY INSTITUTE	141
Some Real-Life Applications			
THE SAILWING WINDMILL	52		
Background			
The New Alchemy Sailwing: How It Works			
How to Build the Sailwing Windmill			
Component Costs			
A Tire Pump for Low Lift and High Volume			
Jim Jacobs's Sailwing			

# Author's Note

IT IS IMPORTANT TO DISTINGUISH WINDMILLS FROM WIND GENERATORS. Windmills are machines that capture the energy in the winds directly for such mechanical work as water pumping, grinding, compressing air, and so forth. Wind generators, which transform wind energy to electricity, can be efficient but are generally more expensive and obviously more complex.

The current, near-exclusive focus on wind generation cannot be taken as evidence of the superiority or even the necessity of producing electricity in all uses of wind energy. Wind-driven water pumpers are designed to operate in lower winds and at lower power levels than wind generators, and thus are able to work in a wider range of locations. The lifting and transporting of water is an appropriate use of wind power because it is a direct mechanical application that requires moderate energy inputs. Energy storage is facilitated effectively and cheaply by storing water for windless periods.

This book describes the use of the commercially available American multibladed water pumper and the New Alchemy-designed Sailwing water-pumping windmill. The decision to use a commercial mill, the Sailwing, or a wind generator connected to an electric pump is strictly up to the reader. There is a different set of circumstances for every site. My intention is to provide a

## THE NEW ALCHEMY WATER-PUMPING WINDMILL BOOK

---

thorough discussion of the available water-pumping windmill options to enable informed and intelligent decision making.

### Acknowledgments

I could not have finished this book without Joe Seale's and Jay Baldwin's superb editing. I wish to note with gratitude the contributions of many others, including John Alden, Tracy Calvin, Tyrone Cashman, Phil Mulligan, M.J. "Ras"

Rasmussen, Joel Souci, Scott Stokoe, Jay Vogt, Mahlon Weir, and the countless volunteers who have given their time to the NAI Sailing projects.

Sections of this book were prepared with the support of the U.S. Department of Energy (DOE), Grant #DE-FG41-79R110051. However, any opinions, findings, conclusions, or recommendations expressed herein are the author's and do not necessarily reflect the views of the DOE.

# Introduction

IN 1977 I CAME TO NEW ALCHEMY INSTITUTE WITH THE PRINCIPAL GOAL of increasing my familiarity with wind and solar systems. It was agreed that I would offer in return my skills as a writer, editor, educator, and laborer.

On the day I arrived, I was immediately drawn, like most visitors, to the graceful whirling of a sailwing windmill, pumping water for a fish culture pond. It was a thrilling sight then, as it is now—the gentle sweep of multicolored blades against the blue sky, swiftly responding to gusts; slowing in moments of calm. And below, the gush and spray of water spewed from the pump, a frothy billowing of cool, life-given aqua. I was struck by the beauty of the machine, but even more by the inherent appropriateness of the quiet, nonpolluting creature.

Like the tides in their lunar concert, the synergy of sun, wind, and wind machine worked in sensible rhythm. And like the tides, the wind-powered ballet, pulsing clean, aerated water, seemed utterly in tune with nature's drama.

Four years later I find myself still here, still learning, and still convinced of the appropriateness of water pumpers for their designated task. In the course of my employment here, I have met and worked with hundreds of windmill professionals and windmill users from Bangkok to Berkeley, from fifteen foreign countries and every region of the United States. And in the course

of my work I began to share what I have learned with potential wind users from all parts of the globe. In the last two years I have met thousands of people interested in water pumpers in courses and seminars here at New Alchemy, and in workshops and consultations on many diverse sites. Through my evolution from apprentice to professional, I've developed some pretty clear ideas of how to design or select windmill systems for different applications. Perhaps of more value is my appreciation of the range and limits of this useful technology.

Water-pumping windmills have a lot going for them. For instance, they are dependable. Of the 6.2 millions mills sold in this country,<sup>1</sup> many hundreds of thousands are still at work today. In many parts of the country and the world, they are the only practical, reliable way to meet range cattle's water needs. A properly installed and maintained wind-powered pump can yield over forty years of service. Recently, some friends and I dismantled an 1893 Corcoran mill that was still pumping after eighty-six years. A regreasing and the replacement of a few parts has it in shape again for at least another eighty.

On the right site, water pumping with the wind is economical. Needless to say, with escalating fuel costs, the relative savings are increasing. On many

1. USDA estimate. Personal communication with Professor M.I. Rassmussen, New Mexico State University, Las Cruces, New Mexico 88003.

sites, windmills are the only economical technology for delivering water, but even in the domestic or suburban application windmills can cost less than conventional energy sources. In 1973, Columbia University Professor Stephen Unger published a note in the *New York Times* in which he analyzed the economics of electric pumps versus windmills. He found that a typical water-pumping windmill costs 50 percent less than a comparable electric submersible pump over the lifespan of the mill, which is rated conservatively at twenty years.<sup>2</sup> I have found in many of my home consultations that families can amortize a water pumper in six years without significant changes in lifestyle or behavior. Home water conservation can make the amortization period even shorter.

Wind-powered water pumping is easy to understand and demands roughly the same skills needed to perform home plumbing tasks or to build a small shelter. In most parts of the country, trained, certified windmill repair persons are available and the best-selling machines usually have ample warranties.

Another important advantage of water-pumping windmills is that a complete system (with storage) is the best fire insurance you can buy. Usually when fires break out at home, one of the first casualties is the electrical wiring. If you

2. Wilson Clark, *Energy for Survival* (New York: Anchor Books, 1975), p. 524.

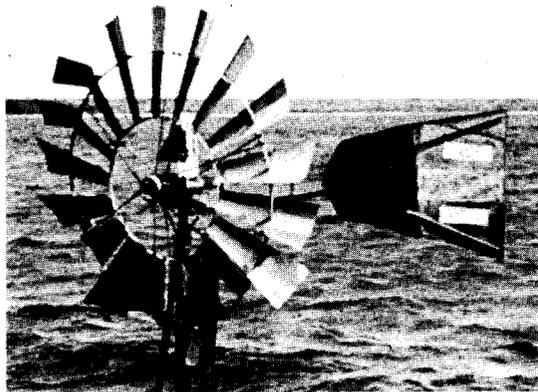

*World's most efficient water-pumping windmill.*

are relying on electrical power for pumping water, to put it bluntly, your goose is cooked. Many fire insurance policies offer sizable discounts for homes with mechanical water systems.

And finally, harnessing the wind for your water needs can be joyful and satisfying, especially during power blackouts. There are few better feelings than using your own local resources to take care of your needs. And for those not yet prepared to completely separate themselves from conventional power sources or those located where winds are marginal, a number of efficient and low-cost compromises are available (See Chapter 5).

This book is written for the potential user of water-pumping windmills for the home, farm, or small commercial application. The information presented here is largely the result of many work-

shops, seminars, and consultations with countless potential windmillers.

Many of the wind enthusiasts I've met are attracted for practical, economic reasons. Others are looking to increase their personal control over their lives. Still others are drawn by the same aesthetic preferences I profess. This book has a little something for everyone.

Readers will not encounter lectures on the merits of substituting wind power for conventional energy sources. This book is for those who are already convinced — those who wish to build a sound basis for determining the next step. To take that step you need a theoretical understanding of the device, economic perspective on the application, and a reasonable, current dose of information about state-of-the-art products from which to choose. This book provides you with all this, and more.

You will find detailed plans for constructing and operating a water-pumping windmill which can be built by most do-it-yourselfers completely from off-the-shelf components. This mill, the Sailing water-pumping windmill, is the result of eight years' research at The New Alchemy Institute. The Sailing is a sturdy, durable machine which does the same work as commercial mills but at a significantly lower cost. We have been able to achieve the cost reduction by designing a machine that requires more attention and maintenance than commercial mills. The windmill described



here is appropriate for those readers who don't mind getting their hands dirty to save a few dollars. It is the most advanced in a family of eight windmills that have been tested in India, California, Boston, and Cape Cod.

And finally, for those of you who intend to

install a commercial or home-built machine, we conclude this text with a compendium of "tricks of the trade." The chapter on installing, maintaining, and trouble shooting your windmill is a summary of considerable experience from around the world.

# A History of the Water–Pumping Windmill

THE FIRST RECORDED WINDMILLS ARE FOUND IN THE SEVENTH CENTURY A.D. in the Persian province of Segistan.<sup>3</sup> These crude but sturdy cloth sail machines were used first for pumping water and later for grain grinding. The operating principle was simple then as it is today — winds would push on a “wheel” of six or more blades, causing the rotor shaft to turn. Power was transferred from the shaft through wooden cogs or gears to a pump or grindstone below. Because the prevailing winds of the region were so constant, windmills of this era were always pointed in one direction and were not built to revolve or “yaw” with shifting wind directions as do their modern counterparts (Fig. 1.1).

The sails of early wind machines developed primarily a drag force. The last few centuries, and particularly recent decades, have seen an evolution of lifting airfoil designs that extract wind power much more efficiently. For an explanation of “drag” versus “lift,” see the insert.

Legends recount that prisoners of Ghengis Khan carried the principle of wind-powered grinding and pumping mills to coastal China. There, mills with matted sails came into use primarily for irrigation. These primitive mills became obsolete by the end of the twelfth century as the application of Chinese sail-making increased the sophistication of windmill construction. The Chinese sail mill, like its Persian predecessor, had an unparalleled lifespan due to its durability

3. Wilson Clark, 1975, p. 519.

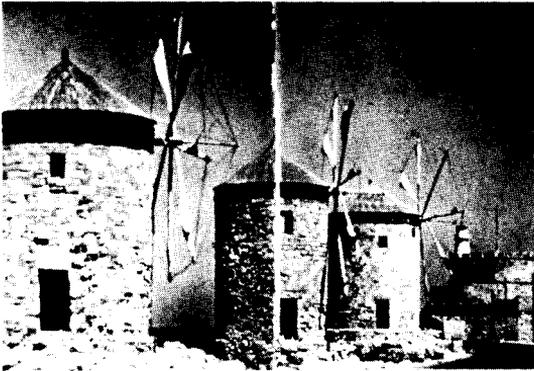

*Figure 1.1. Persian windmills.*

and simple, lightweight design. It gained widespread application throughout coastal China. These same advantages explain the ubiquitous employment of sail mills in southern Asia, Africa, and the Mediterranean regions today (Figure 1.2).

The European mill appears to have developed independently from its very dissimilar Asian counterpart. The first account of windmills dates from 1105, when a French permit was issued for the construction of a water-pumping machine. A

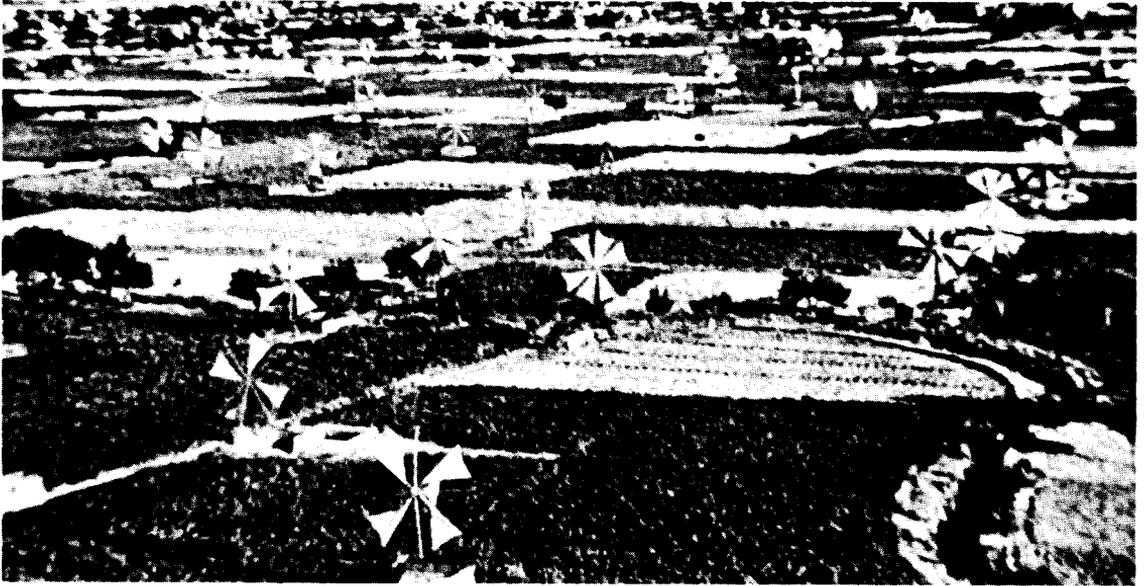

*Figure 1.2. The Plains of Lassithi, Crete.*

## DRAG versus LIFT

Aerodynamic forces are divided into "drag" and "lift." "Drag" is defined as the force pointing downwind, parallel to the flow of air. "Lift" is the force pointing perpendicular to the wind. Thus, a sailboat moving at right angles to the wind relies on aerodynamic lift to make headway. An airplane is lifted up, perpendicular to the flight path by the wind crossing its wing.

Drag is caused by the conversion of smooth airflow to turbulent eddies. Lift is caused by an airfoil cutting across the wind and absorbing energy without creating turbulence. For a machine using lifting airfoils, the theoretical efficiency limit is double that for a wind machine based on drag forces. A dragging sail converts at least as much wind energy into turbulent wake as it converts to mechanical power.

Almost all wind machines use a combination of lift and drag forces. The best airfoils achieve a lift-to-drag ratio of over 100-to-1. As a result, aerodynamically clean, lifting airfoil wind turbines actually achieve better than twice the efficiency of drag-dominated machines.

deed from Britain, dated 1180, reports the same type of permit.<sup>4</sup> The earliest mills were probably Archimedean drainage pumps like that shown in Figure 1.3. In good winds, these relatively efficient mills could lift up to 16,000 gallons per hour but could not lift water more than 16 feet. The same limitations characterized the thirteenth century Dutch scoop mills, which turned enormous water "scoops" lifting large volumes of water into higher basins or canals. These drainage machines were often arranged in "gangs" or successive stages and were effective in transforming large water bodies into crop lands (Figure 1.4).

The thirteenth century saw windmills gain widespread acceptance, and in the fourteenth cen-

tury Dutch "tower" mills for pumping and grinding became common. Among these was the ingenious "post mill" — a timber framed building and wind rotor designed to balance and rotate on a single vertical post (Figure 1.5). The European mills used canvas sails, stretched across wooden lattice frames.

By the end of the sixteenth century many thousands of windmills were pumping and grinding in western Europe, a number so significant that in the early 1600s a Bishop of Holland claimed the wind as his own and imposed an annual duty on windmill owners. During this period many interesting advances occurred in windmill blade design. There were many crude attempts at increasing blade efficiency and more than a few

4. Wilson Clark, 1975, p. 520.

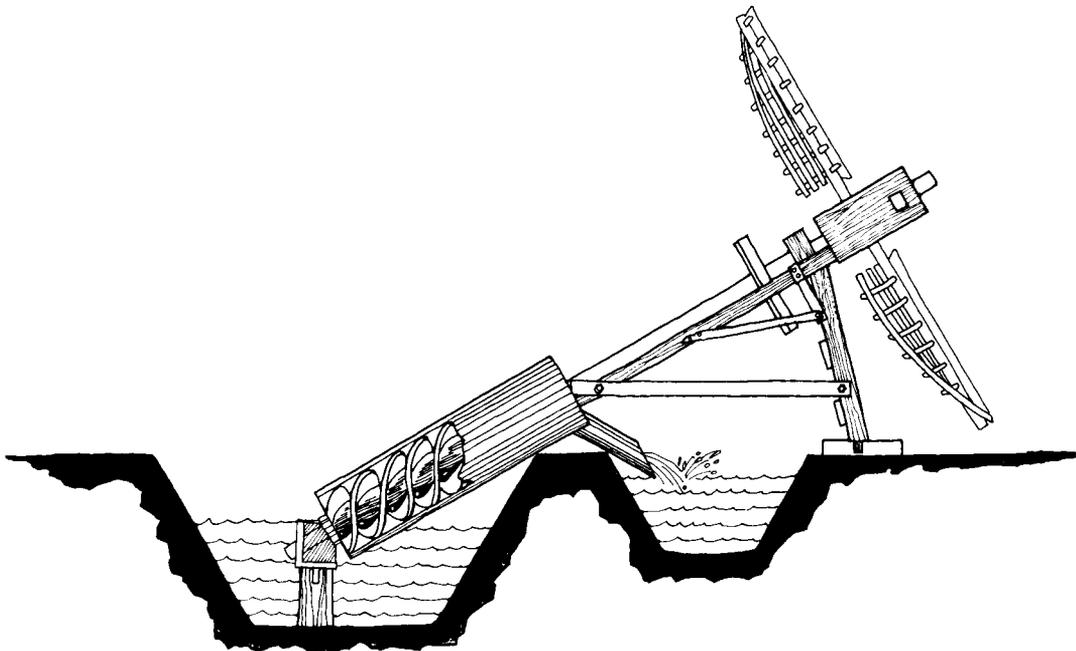

*Figure 1.3. The simplest drainage mill;  
the Frisian tjasker.*

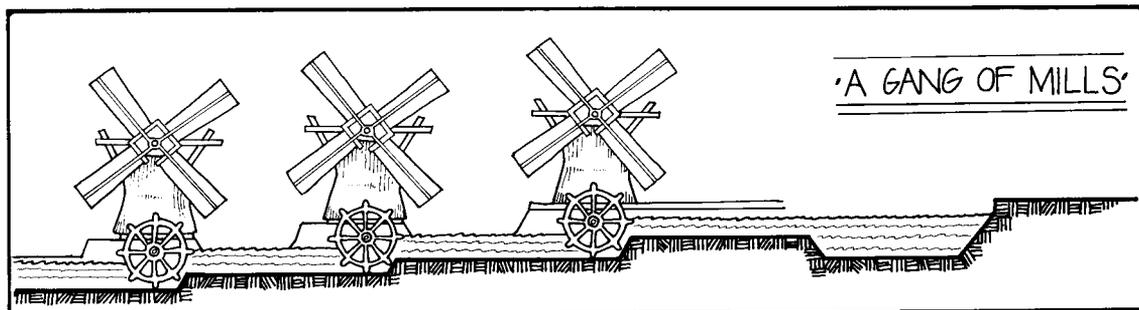

*Figure 1.4. A "gang" of mills.*

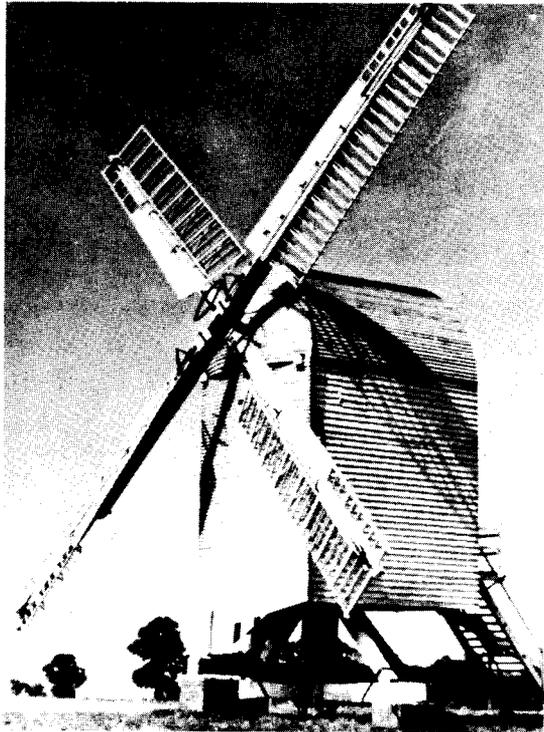

Figure 1.5. A "post-mill."

were successful. The Dutch millright Leeghwater was among the more notable innovators of the era. He got his name — literally, "empty water" — because he personally used windmills to drain over twenty-six lakes in his lifetime. Jans Drees, in a fascinating article entitled "Blade Twist, Droop Snoot, and Forward Spars" describes how Leeghwater applied sophisticated aerodynamic principles to his trial-and-error blade modifi-

cations several hundred years before aerodynamics became a science.<sup>5</sup> Leeghwater's innovations with blade twist, drooped leading edges and varied mast placement permitted great advances in the wind machine's ability to perform pumping tasks.

By the late nineteenth century, there were more than 30,000 windmills operating in Western Europe.<sup>6</sup> Many mills from that era were employed in this country, and some are still maintained today (Figure 1.6).

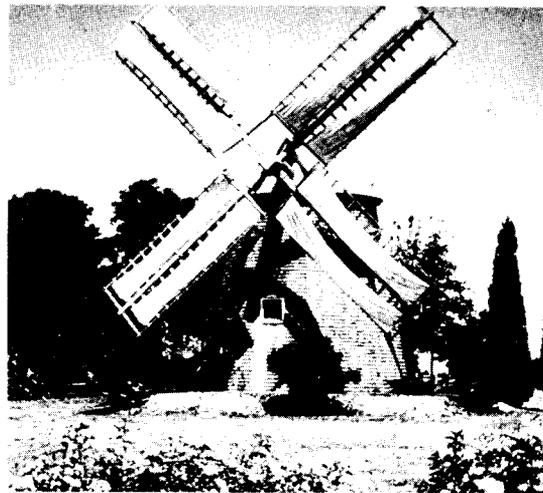
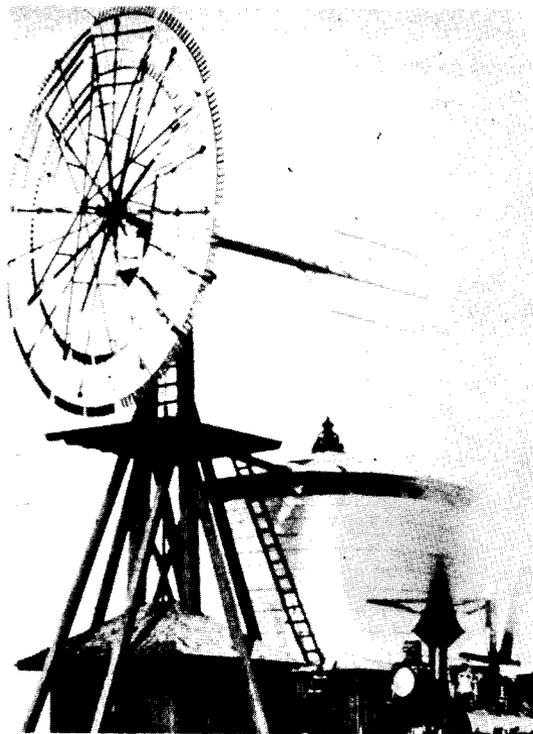

Figure 1.6. A working Dutch windmill in Brewster, Mass.

5. Jan M. Drees, "Blade Twist, Droop Snoot, and Forward Spars," *Wind Technology Journal* 1(Spring, 1977): 10-16.

6. Wilson Clark, 1975, p. 521.

The American multibladed windmill bears little relation to the European mills. During the great Western railroad thrust, steam locomotives needed dependable water supplies, particularly in the dry, remote plains. Steam-powered pumps were a costly, inefficient way to service the locomotives. With classic Yankee ingenuity, Daniel Halliday invented the American multibladed



*Figure 1.7. A "Halliday" water-pumping windmill (c. 1855).*

windmill in Windsor, Connecticut in 1854.<sup>7</sup> One of his first 26-foot-diameter windmills is pictured here (Figure 1.7). Unlike the Dutch scoop mill which was incapable of lifting water more than 16 feet, Halliday's mills could draw water from hundreds of feet below the surface. He sold thousands of these machines and spawned an industry which saw over 300 manufacturers producing windmills

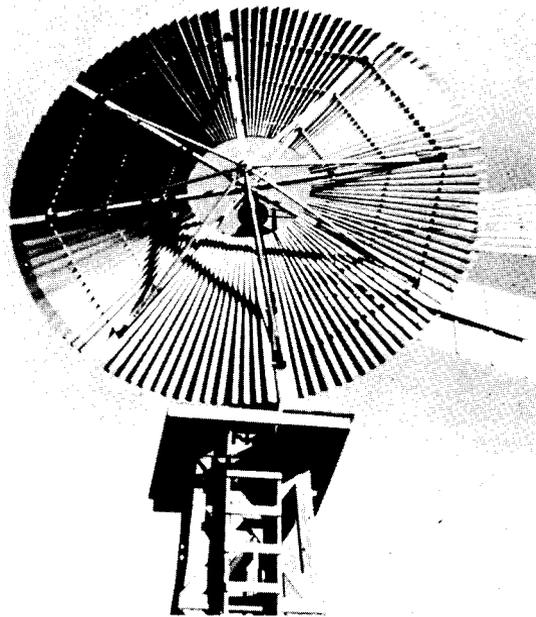

*Figure 1.8. A wooden-bladed water-pumping windmill.*

7. "Selecting Water-Pumping Windmills," (New Mexico Energy Institute, P.O. Box 3E1, Las Cruces, New Mexico 88003), 1978, p. 1.

by the turn of the century. These wooden-bladed beauties still relied heavily on aerodynamic drag but had the twisting features of crude "lift" airfoils (Figure 1.8). Since almost all the wind machines of this era were open-g geared, cowboys on large ranches were sent out each week with oil-filled saddle pouches, or with corked whiskey bottles filled with replacement oil, to keep stock-watering mills in good shape. Most cowboys detested these machines as they did all mechanical devices — "can't eat a windmill when things get rough."

In 1886, Thomas Perry designed a more aerodynamic steel blade, and that design is still employed today. In 1915, the Aermotor Company of Chicago brought joy to a great many cowboys when it patented the first self-oiling machine, which simply enclosed the open gears in a water-resistant case. This early and decisive advantage catapulted the Aermotor into popularity as the most widely distributed wind machine in the history of the business, accounting for 70 percent of all sales in the 1920s.

But even the convenience of a self-oiling water pumper did not obviate the need for at least one annual lubrication. Modern-day wind enthusiasts may find compassion for young Sietze Buning, who writes of confronting his fear of heights in a 1944 poem.<sup>8</sup>

8. S. Buning, "Greasing the Windmill," *Dialogue* (Grand Rapids, Michigan: Calvin College), 1978.

## Greasing the Windmill

June 11, 1944

Sietze Buning

It took Dad and me from afternoon on one day  
until the sundown the next  
to grease the windmill.

The first afternoon we went to town  
for a six-pack of beer,  
put the beers into a gunny sack,  
and hung the sack in the well on clothesline.  
The mill above the well looked shorter than forty feet.

The next morning after milking and breakfast  
we walked into the pasture.  
Dad had an empty bucket to drain the old oil into  
and I new oil in a new tin can.

Dad sighed  
and started up the ladder,  
each foot on a step for five steps,  
then both feet on one step for three steps,  
and then stood on the eighth step  
complaining of dizziness.  
He came back down.

It was my turn.  
I made it twelve steps up,  
one foot on a step but breathing hard,  
when Dad called up that I had the new oil.  
I had to go back for the empty bucket.

It was harder my second time  
and slower with the bucket. The whole mill  
shivered in sympathy. I managed only to peek



onto the platform, to lift the empty bucket above  
my head with my free hand, and tip the bucket  
onto the platform. Then I too was dizzy.  
I came down, the old oil  
still undrained.

Getting the better of ourselves  
proved time-consuming. By now it was  
coffee time. In the kitchen we admitted  
to Mother that all we had achieved  
was an empty bucket  
on the platform.

Mother reminded us that my brother Klaas,  
now, alas, in service,  
used to grease the mill on his way to catch  
the school bus,  
starting out a half-hour early. And he never  
even had a drop  
of grease on him at school that day.

Mother reminded us that Gerrit Henry,  
Klaas's friend around the corner,  
not in service and available,  
went up his dad's windmill  
with the full can and  
the empty can,  
drained the old  
oil, spread-eagled  
himself flat against  
the wheel, and had his dad  
put the mill in gear. Afterwards  
he said it had been better than a  
ferris wheel. Running the mill  
had got the last drop of oil

out, and he had added the new oil  
before coming down, all in one trip.  
Why couldn't we be like that?  
She might as well have said,  
"Napoleon:  
now there's a hero for you!"

In the pasture after coffee  
Dad said, "We'll never make it  
without the beer." He had hoped  
he could bring the sixpack back to  
Doc's Cafe, untouched. The trickle  
and then the drip from the gunny sack,  
the haul of the cold clothesline, and then  
the beer itself, all would have restored us  
if we had been thirsty and tired. We were  
afraid, not thirsty and tired, and the  
beer was our bitter anesthetic.  
We needed a bottle apiece  
for a full dose.

It was guilt  
and not the beer  
that got Dad to the top.  
He had to prove to himself  
that the beer had been necessary.  
How explain the beer to God come Judgment  
Day if he couldn't show that the beer had helped?

I cheered when he made it: Oranje boven! And I  
cheered  
again when he opened the petcock and drained the old  
oil out  
into the bucket I had delivered earlier at such pain. But  
his eyes

were bright as brimstone looking down, the guilt still there.

How could he ever know for sure he hadn't faked the fear

to justify the beer? He trembled all the way down, step by step, rung by rung, the full bucket tilting ominously as he changed it from one hand to the other. The wind whipped spatters over his bib-overall and cast-off Sunday tie. I remembered Klaas greasing the mill, clean.

We put the windmill in gear.

Three revolutions would have cleaned it but we let it run longer to get it really clean.

Need I add that nobody was spread-eagled against the wheel?

We talked about the relativity of height, depth, space, and time, postponing the minute when I would need to go up with new oil.

When we could think of no more to say, I started up.

On the twelfth step I glanced at my wristwatch.

We had talked for a half-hour: it was an hour since our beers, "My beer's worn off,"

I called down, "I'm dizzy from the height.

I'm coming down for more beer."

But what would Mother say

if she smelled the beer

at dinner? We decided

to wait till afternoon.

At dinner Mother assumed

we were finished.

She greeted us like conquering heroes.

We had to admit only the old oil was drained out.

Had she known that, she muttered, she would have made sandwiches and not killed herself fixing porkchops and apple pie, and enough was enough, we should get Gerrit Henry.

I waved her still

with bravado I didn't feel

and Dad prayed at table.

He might as well have prayed outright for God's blessing on my perilous journey.

As it was, he prayed for God's blessing in all difficult circumstances and paused and swallowed.

No doubt from that moment legions of angels hovered around me but I was too frightened to consider angels.

At prayer I considered these fragile folded bones called hands and at dinner I choked on my porkchop and refused my pie.

After dinner

the windmill had doubled in size in the full glow of an Iowa afternoon.

Dad and I began with a beer apiece on the ground.

Who knows? If I failed again, he would need to be ready.

Actually, I surprised us both. I scrambled up, poured the oil in, closed the petcock, and threw the empty tin down. It bounced higher than Dad's head! What a height, to make a can bounce higher than Dad's head.

Promptly I was paralyzed.

"You done real good," Dad called, "come down."

"Wait till I get a notion," I said, and didn't budge.

"I'll go home for tea without you."

I could do nothing.

"There still are two beers in the well."

I still could do nothing.

"Must we get Gerrit Henry to fetch you down?"

Mention of Gerrit Henry

made me go prone on the platform, clutch the edge, hunt for the spokes and undertake my quavering descent.

Then it was tea-time.

Mother poured us tea  
but gave us no hero's welcome.

After tea, we did chores,  
after chores, we milked,  
after milking, we ate supper,  
and after supper, Dad remembered the beers.  
You couldn't return two beers out of a six-pack to  
Doc's Cafe.

That beer —  
with Dad in twilight  
at the mill

all fear gone,  
well, as gone as fear ever gets —  
that beer is the only beer I have ever enjoyed.

But Mother's diary is too spare for June 11, 1944:  
"Dad and Sietze greased the mill today."  
If ever I did a day's work, I did it that day.

Water-pumping (and electrical) windmills boomed until the early 1930s when the Rural Electrification Administration (REA) was established to provide federally subsidized power to remote homes and farmsteads. In the period from 1880 to 1930 the combined capital investment in the American windmill industry grew from less than \$700,000 to \$4.3 million<sup>9</sup> (Figure 1.9). Although it took several decades to "wire" remote locations, the windmill business crashed after 1930 and laid fallow until recent years. Of course, hundreds of thousands of windmills stood (and still stand) throughout the country, and three companies continue doing a moderate business into the 1980s — the Heller-Aller, Dempster, and Aermotor Companies (See Figure 1.10). Addresses for these manufacturers are listed in the appendix.

Today, besides the machines of three major manufacturers, a wide range of less expensive water-pumping wind machines are on the market including the Sparco and Bowjon mills. The Mishler windmill, from Beverly, Kansas, and the Mexican Movisa are essentially copies of the

9. Wilson Clark, 1975, p. 522.

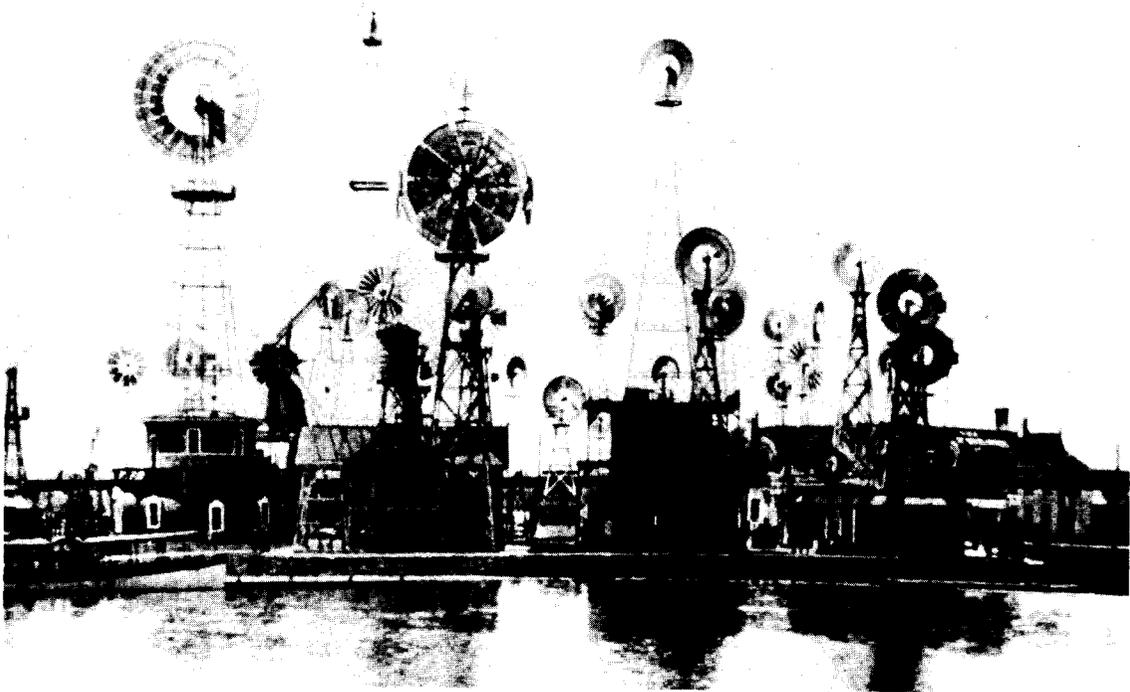

T. Lindsay Baker

*Figure 1.9. The Chicago World's Fair, 1893.*

major manufacturers' machines. And it appears that a number of very expensive, higher-technology devices will soon be marketed for large-scale irrigation and industrial use.

In addition, a wide range of do-it-yourself windmills are available from many sources. Plans are available for mills such as the Cretan jib sail, the Arusha, and the Palomo. Third World assis-

tance agencies such as VITA, AID, ITDG, and others distribute windmill designs and plans (see Appendix). These mills are generally designed around particular circumstances characterized by low winds, shallow wells, or cultures where people tend the machines during pumping operations.

The New Alchemy Sailing was inspired in

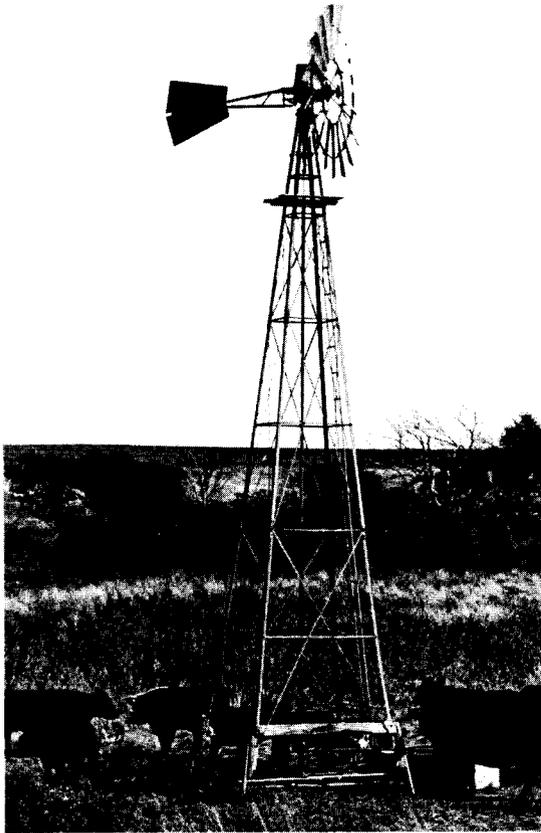

*Figure 1.10. A modern waterpumper.*

part by virtually all of these machines. The Sailingwing is designed to compete against commercial mills in terms of performance, but at greatly reduced costs. Because the wind rotor is made of sail cloth, the New Alchemy Sailingwing requires more maintenance than do its commercial



*Figure 1.11. A reconstructed Cretan windmill at the Windfarm Museum, Martha's Vineyard, Mass.*

counterparts, yet far less than most of the Third World or do-it-yourself machines. The NAI Sailingwing can run untended in winds up to 40 mph, above which it should be furled to "half mast." A simple brake allows the miller to bring the machine to a stop so he or she can furl the sails.

In very rough dollar terms, the NAI Sailingwing (about \$1,300 installed) can do the job of a \$3,800 to \$4,500 installed commercial machine.

A comparable Third World machine might cost from \$300 to \$600 but requires constant tending.

The next two chapters present a basic explanation of the standard commercial wind machine. Chapter 4 contains construction plans and a discussion of the New Alchemy Sailwing. Interested readers can find the addresses for other types of water-pumping windmills in the Appendix.

In concluding this chapter, two points deserve mention. First, there is a wonderful museum of the history of wind power on Martha's Vineyard, Massachusetts, appropriately called the Windfarm Museum. The Tailer family has assembled a delightful and important collection of old and modern wind machines (Figure 1.11). Second, for those interested in the history of American multi-

bladed windmills, the most knowledgeable person I have met is T. Lindsay Baker from the Panhandle Plains Historical Museum in Canyon, Texas.

There is a different wind system appropriate to every site and circumstance. It would be folly for me to recommend one machine over the other since such criteria as wind speeds, water use, parts availability, and manufacturer and dealer accessibility will vary from site to site.

The next step in the rich and colorful history of wind power will be yours, and you won't be alone. Windmills are on their way back. These gentle symbols of the past are also the banners of the future — symbols of a renewed kinship between humanity and the forces that sustain us.

# The Water–Pumping Windmill System: How it Works

UNDERSTANDING THE BASIC COMPONENTS OF A WATER-PUMPING WIND-mill System (WPWS) is of fundamental importance in determining the right system for a specific job. This chapter will begin with a discussion of the basic components — the well, wind-mill, and storage/delivery systems — and we'll conclude with some examples of non-conventional systems.

## THE WELL

Entire textbooks are devoted to the subject of water wells, and a number of very good guides are available (See Appendix). Well technology is beyond the scope of this book, but a few general points deserve mention.

Wells can be drilled, driven, or dug. In most cases it is advisable to hire this job out to a professional. Well construction is tricky work, and even small mistakes can be costly. Carelessness or inexperience often results in a polluted or contaminated well — problems which can take years to correct. Frankly, I have not yet seen a homestyle well rig that is worth its cost. Professional well drillers can get the job done right in a short time.

You'll want to make sure your well driller tells you your drawdown, that is, the rate at which the water is replenished at different depths. Wells with a rapid drawdown have a

slow replenishment rate. This situation is more likely with a high-speed, high-volume conventional pump than with a windmill, but it is an important consideration nevertheless. For instance, let's say you've installed a windmill pump that is a good match to your well's replenishment rate. A few years later you find that the in-laws have moved in and peak period water use increases to the degree that a backup electric submersible pump is needed. If your submersible pump draws the water down faster than the well can supply it, you can count on replacing a burned-out pump in short order. Electric submersible pumps must be submerged at all times or they overheat. Generally the way around this and other well-related problems is to have your well drilled to a depth of 20 feet below the water table at the driest time of the year (August in New England, for instance). This deep water reservoir gives the owner a comfortable margin of safety in case of a poor replenishment rate or drought.

Usually the well driller "cases" the well. Casing, lining the actual well hole within pipe or "case," is a must in sandy terrain like that of Cape Cod. You have to choose between plastic and steel casing. Plastic is by far the cheaper material, but beware: it does become brittle after a few years.

Another point that must be considered is well diameter. The proper well diameter will depend on a great many factors as detailed in the next chapter. If you are starting from scratch, the best

advice is to think through the entire process of installing the appropriately sized windmill system. You will find that foresight can save you hundreds or thousands of dollars. For instance, in freezing climates, having your driller start the casing in a pre-dug pit, so that water transport is always below the frost line, can save you much work and money if done at the beginning (See Figure 2.1).

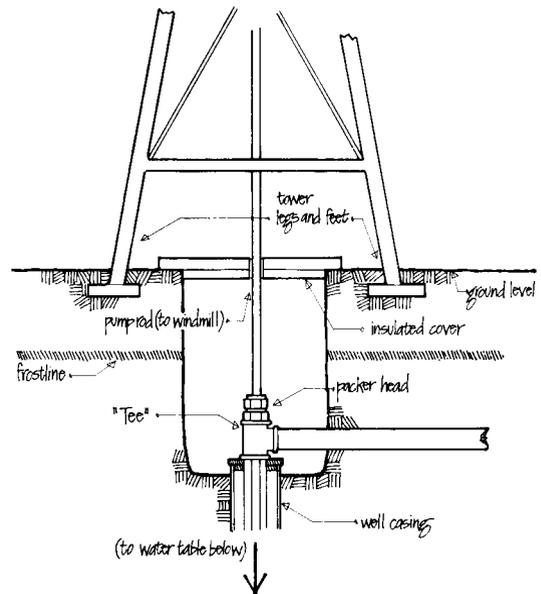

*Figure 2.1. A well for freezing climates. In freezing climates, well heads must be below the frost line so that the water pipes won't be exposed to freezing temperatures. The pre-dug pit is insulated after the wind pump is installed.*



## SYSTEM COMPONENTS

Excluding the well and storage facilities, a conventional WPWS consists of most of the basic components shown in Figure 2.2.

### THE WHEEL OR ROTOR

The wheel or rotor is the part of the machine that catches the wind's energy and converts it to rotary mechanical power which is available for work.

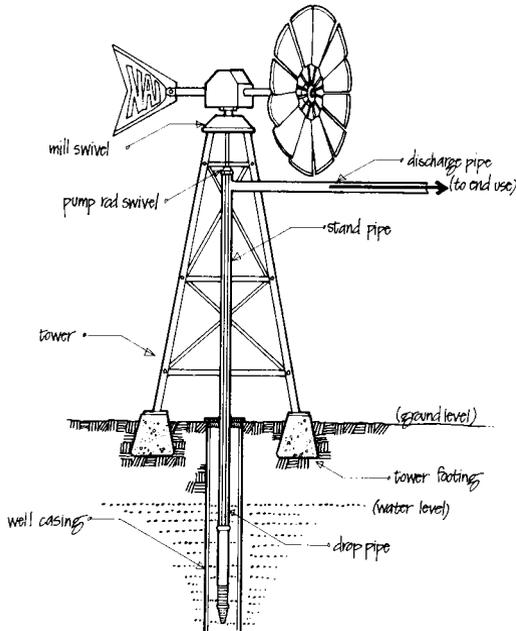
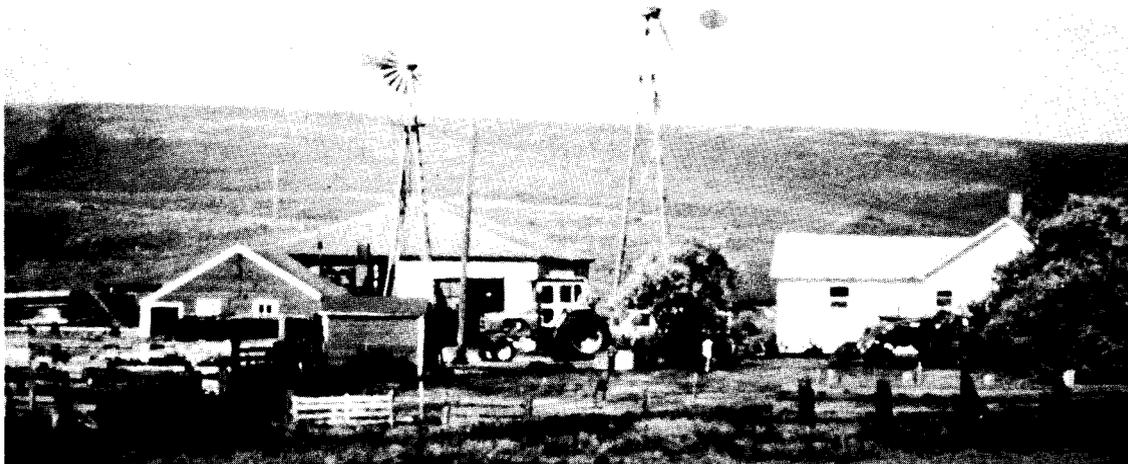

Figure 2.2. A complete water-pumping windmill system (WPWS).

Let's imagine that a circle represents the perimeter of a rotating windmill rotor. This area is known as the "swept area." Now note Figure 2.3. The conventional multibladed water-pumping windmill rotor fills a much larger portion of the swept area than does the sleek, aerodynamic wind generator rotor of the same (6-foot) diameter. In windmill terms we would say that the water pumper is a high "solidity" windmill compared to the wind generator. High rotor solidity provides the starting torque needed for the difficult first pumping stroke when the wind comes up. Once spinning, a high-solidity wind turbine is unfortunately much less efficient than a low-solidity turbine. The problem with a low-solidity turbine is that it simply does not get enough blade area in front of the wind to start a pump. Once the blades are moving fast, they catch wind over the entire disc area by "sweeping" the disc rapidly each second. Hence, a low-solidity turbine could in principle drive a water pump efficiently *if* the turbine could be disengaged for starting.

High torque is important when it comes to starting mechanical devices like water pumps but is not required to start electrical generators or alternators. Water pumps usually have a load of water they are trying to lift at the same time the wind rotor is beginning to turn, whereas electrical generators offer little starting resistance. On the other hand, economical generator designs require



Gary Emerson

*Figure 2.3. A low-solidity, high-speed wind rotor for electricity generation (right) and a high-solidity, slower-speed wind rotor for mechanical applications (left).*

high rotation speed. This is achieved with the least extreme gearing by using low-solidity, high speed wind turbines for electrical generation.

In summary, high-solidity rotors best match the requirements of water pumps, and low-solidity, high speed rotors are the best choice for electrical generation.

Water-pumping windmills are normally designed to be most efficient in relatively light winds. The recommended combinations of rotor size, pump displacement, lift, and gear ratio (as

given in the design table in Chapter 3) permit fairly low starting wind speeds but result in low pumping efficiency in moderately high "power" winds. Water pumpers are designed to meet demands under worst case conditions. By contrast, electric-generating windmills are optimized for higher wind speeds and higher power levels (for a given rotor diameter). The goal for electrical generation is a compromise between efficiency in moderately low winds and maximum total energy delivery each year. The emphasis is

usually toward maximum kilowatt hours per year rather than worst-week performance. This means that wind generators are usually poor performers in light winds, whose net annual energy content is low.

Since water-pumping windmills are simpler devices than wind generators, they are cheaper for a given rotor size (at least for small-scale machines). This means that the required minimum economical wind speed average for a water pumper is lower than that for a wind generator. It also means that economic optimization calls for less tower investment, hence, shorter towers for water pumpers.

Rotor diameter is a critical factor in determining the appropriate machine for your needs. The diameters of commercially available wheels range from 6 to 16 feet. I'll discuss how to select the correct diameter in the next chapter. For now, you should know that the power of a wind machine is proportional to the swept rotor area, which increases with the square of the rotor diameter. The equation is  $P=KD^2$ , where  $P$ = the power available from a wind machine,  $D$ = blade diameter, and  $K$  is a constant that depends on wind speeds and system design. If the blade diameter is doubled, the power output is quadrupled ( $2^2=4$ ). This suggests dramatic increases in power when increasing blade diameter, but because the larger rotors have larger swept areas, the costs of engineering rotors and towers to withstand higher

forces also rise considerably.

In general the modern, conventional water-pumping windmill rotors have a reputation for durability. They are all equipped with automatic furl-out devices which actually turn the rotor out of the wind during dangerous wind conditions. This feature avoids damage to the pump and other components which are not designed to work at high speeds. It also means that water pumpers can work for long periods without attention. Only in hurricanes does one need to worry, and special precautions can be taken in such circumstances (See Chapter 5 for "tricks of the trade"). All of the commercial windmills also have manual emergency brakes for quick furling.

#### THE GEAR BOX OR TRANSMISSION

The windmill rotor connects to the gears and crank mechanism which convert rotary motion into vertical motion for pumping (Figure 2.4). Typical gear ratios are 4:1, that is, the rotor turns four times for one pumping stroke. Some companies are experimenting with 5:1 ratios for increased torque and lower starting wind speed.

Gears and their housing are costly to manufacture and they need to be constantly coated with oil. Most commercial water pumpers have closed gearboxes and require only an annual oil change. The New Alchemy Sailing and other home-built windmills attempt to circumvent these costs by using ungeared crankshafts and sealed bearings.

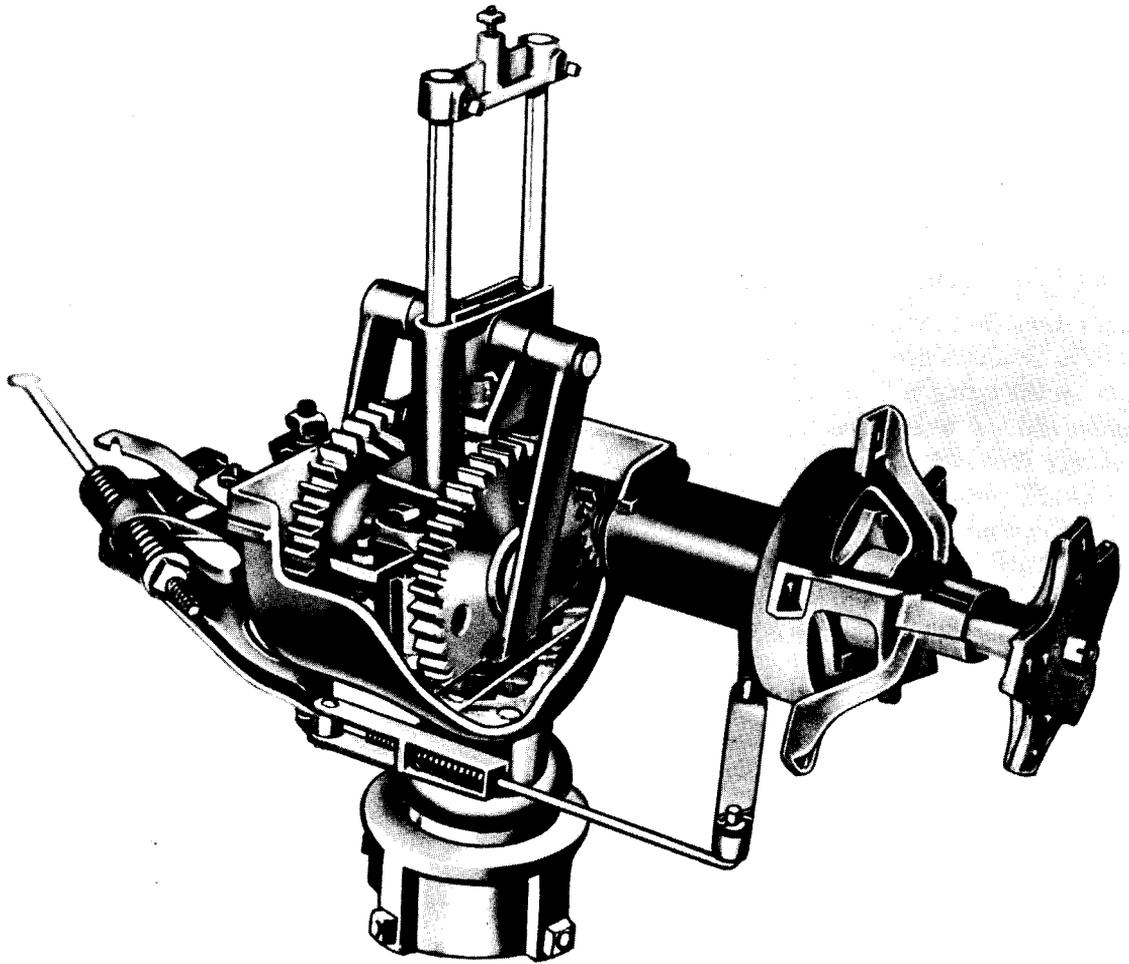

*Figure 2.4. A water-pumping windmill gear box*

## THE TAIL

Windmills can operate either upwind or downwind. Upwind machines require a tail to keep the nose or rotor into the wind. The disadvantage of a tail lies in the cost of extra materials. The advantage is that in high winds it can be pulled parallel to the wheel by a spring attached to the gearbox. This self-furling mechanism, which can be adjusted by altering spring tension, effectively shuts down the mill and prevents self-destruction in high winds. When the gusts subside, the tension on the spring pulls the tail back behind the wheel and the wheel turns back into the wind. Another advantage of a tail is that when the wheel is upwind, the tower does not interrupt the wind going to the blades, which can cause serious vibrations in high speed windmills. In spite of this advantage, we chose a downwind design for the New Alchemy Sailwing in an effort to develop the lowest cost water pumper possible. Furling of the Sailwing is accomplished by the sails' ability to spill wind rather than by yawing the entire rotor out of the wind. I don't know of another downwind water pumper on the market today but many home-built machines are also downwind. On all windmills, the entire top assembly including the wheel, tail, and gearbox are mounted on a turntable or shaft, sometimes called the "lolly column," which allows rotor orientation by yawing with changing wind direction.

## THE TOWER

The most important consideration for the tower (Figure 2.5) is to get the wheel above nearby wind obstructions. As a general rule, the tower should be no less than 25 feet taller than any obstructions to wind flow within 100 yards of the mill in all directions. Commercial towers available from water pumper manufacturers range in height from 21 to 47 feet. For higher towers, consult wind generator catalogs.

The tower must be absolutely plumb and the tower-top platform level, or the lifetime of the machine will be drastically shortened. Needless to say, the tower must be strong enough to support the rotor and to withstand the maximum anticipated wind stresses. Manufacturer's specifications are detailed and precise. Should you choose an alternate tower, look carefully at the stress specifications, and be very sure not to cut corners. Cost savings vanish when the machine has to be retrieved off the ground after a storm.

When building your own tower, use only high-quality bolts and hardware. On a well-built tower every bolt should be in tension. Bolts from an old tower may be fatigued and worn from tower stress and should *never* be re-used. Consult an engineer or local concrete contractor on footing specifications. On Cape Cod, we use 3,500-pound compression concrete for towers under 35 feet tall.

As to choice of building materials, wood looks

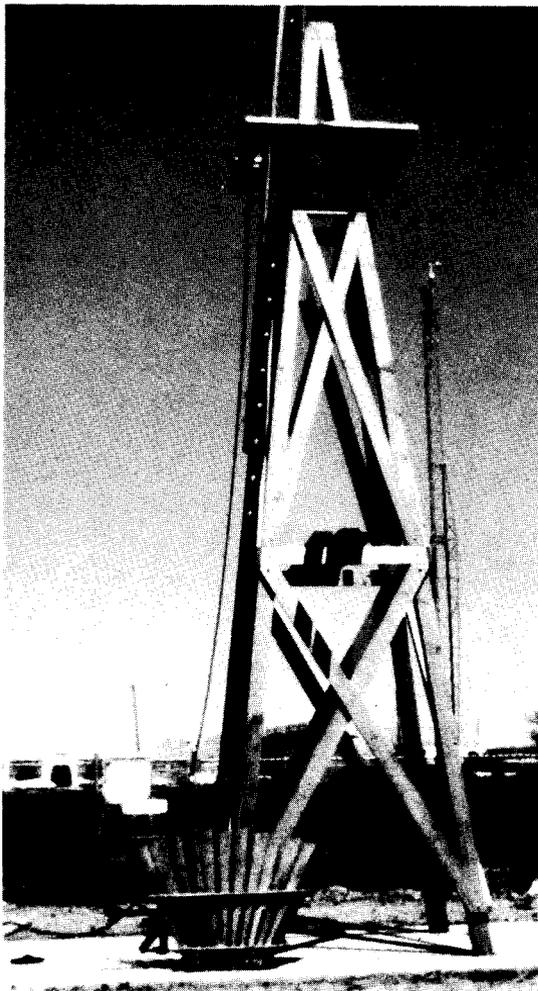

*Figure 2.5 A 40-foot wooden windmill tower.*

nice, but is economical only in regions like the Southwest, where the climate is dry. In climates with any moisture at all, it's better to go with steel. We've tried a number of wooden towers but I don't believe any of the designs will last longer than eight years. Preserving wood is an expensive and potentially poisonous way to add a few years to your tower. However, in the Southwest, I've seen redwood and other wooden towers that are still sturdy after seventy years.

Many modern wind generators are being designed to mount on telephone poles. Telephone poles are cheap (\$7 per foot in our area), available, and preserved to withstand rugged climatic conditions. They may be the one exception to the wooden tower rule, but are generally not useful where a reciprocating vertical pumpshaft is involved. One Virginia windmill company has developed a promising telephone pole mount for the water pumper. We'll discuss this machine in Chapter 4. Here on Cape Cod, we have decided to go with steel. It's dependable, virtually maintenance free, and most steel towers will outlast any of us.

Many people ask if it is a good idea to mount a short tower on the roof of a building. Most buildings cannot take such stresses without reinforcement, and the inevitable vibrations can damage the structure as well as drive people crazy with the rumble. Moreover, a disaster might include the machine falling into the building. In

most cases, the answer is no—we do not recommend roof-mounted installations.

## THE PUMP CYLINDER AND DROP PIPE

To understand the water pumping system, we should now go from the bottom up.

The WPWS uses a positive displacement, or piston, pump. The cylindrical piston, pump is submerged at least 10 feet below the water table, and is threaded to a water pipe called the “drop pipe.” The drop pipe is the pathway for water from the pump to the ground level above.

Figure 2.6 details this simple device. The pump

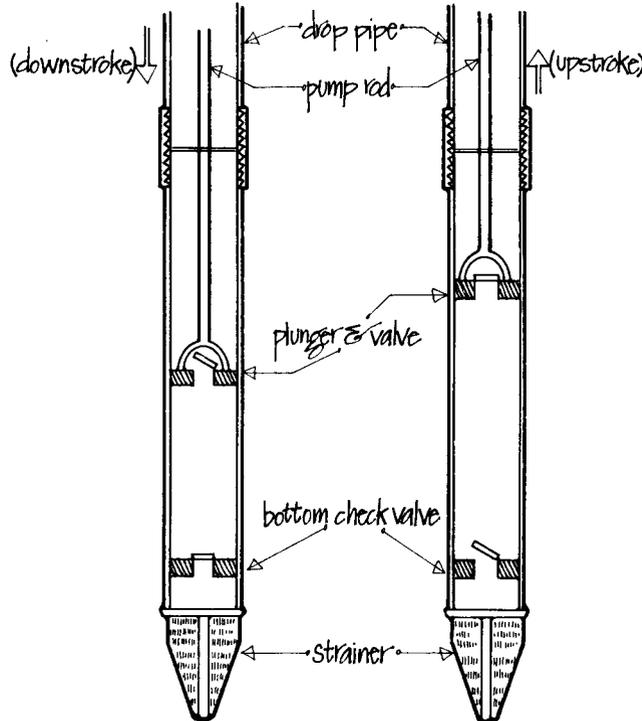

Figure 2.6. The windmill pump cylinder.



**Figure 2.7.** *The windmill pump cylinder.* is made up of four parts. The "cylinder" (Figure 2.7) is the actual pump body; it has a very smooth inner lining usually coated with epoxy. Threaded to the bottom of the cylinder is a "strainer" or screen which keeps sediment out of the water supply. The "bottom check valve" is a stationary one-way valve that allows water to move only upwards towards the surface. The upper plunger and valve is another one-way check valve surrounded

by a leather ring designed to conform tightly to the cylinder wall. The plunger is connected to the windmill by a long steel rod, and it travels up and down through a constant stroke length determined by the windmill rotor and gear assembly above. As the upper plunger travels up (the "up-stroke") it lifts the water above it in the drop pipe and creates a suction inside the cylinder which opens the lower check valve, pulling water into the barrel. At the top of the windmill stroke, the plunger begins to travel downward. The water pushes open the upper check valve but closes the lower check valve with the weight of the water column. At the bottom of the stroke, the plunger reverses direction and repeats the up-stroke procedure.

The leather ring around the upper check valve is a weak link in the windmill system. Because they do all the work and are constantly in motion, "leathers" wear and require replacement roughly every three years. This task is relatively simple and inexpensive — the tricky part is retrieving leathers to the surface.

You can purchase either of two types of cylinders: "open-top," or "closed-top" (Figure 2.8). The closed-top cylinder is not completely closed — water still passes to the drop pipe through a smaller hole. It is less expensive, but because of the smaller hole, the plunger and leathers cannot be retrieved without lifting the entire pump *and drop pipe* to the surface. Since the bottom check



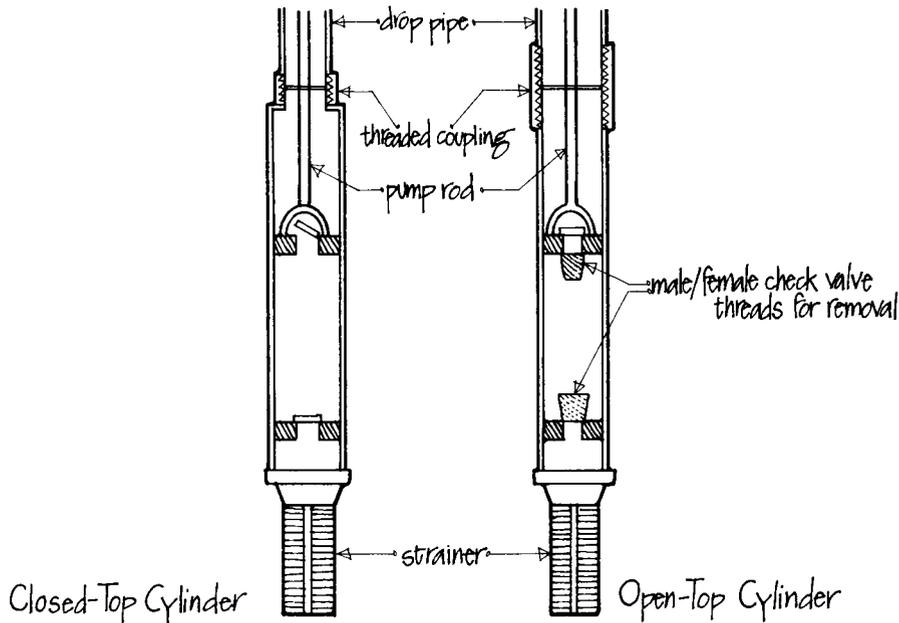

*Figure 2.8. Open-top vs. closed-top pump cylinders.*

valve also cannot be lifted through the pump top, pulling the pipe and pump also means lifting the entire weight of the water column — about five pounds per foot of 2-inch water-filled pipe. Thus the closed-top cylinder is only practical in shallow wells.

The more expensive open-top cylinder is usually all brass and allows both check valves to be pulled to the surface by means of the pump rod. This releases the weight of the water column, does not necessitate pulling the entire drop pipe, and is thus

appropriate for deep wells up to several thousand feet.

A number of companies are trying pump leathers made of neoprene and other hardier materials which still conform to the cylinder wall. There appears to be little advantage to synthetic leathers as they too wear and score from grains of sand over time.

The drop pipe, which can be a good grade galvanized pipe of any size, fits inside the well. At the top it is screwed into a tee or coupling which

keeps it from dropping into the well. The drop pipe should be slightly larger than the cylinder to permit removal and replacement of the pump leathers without having to pull up the whole pipe. It is important that the drop pipe be smooth on the inside. Otherwise, replacement leathers will be damaged when the plunger is lowered back into the cylinder. A special well-pipe coupling, called an Artesian coupling, is preferred for this job. It is threaded so that the pipe ends actually abut one another, forming a smoother surface for leather replacement.

The plunger diameter and length of the plunger stroke are major factors in the windmill's pumping capacity. Standard cylinders range in diameter from 1 $\frac{3}{8}$  to 4 inches. It is best to stick with a 1 $\frac{3}{8}$ -inch cylinder if possible, to permit leather removal through a standard 2-inch drop pipe. Costs rise rapidly for pipes larger than 2 inches in diameter. In my locale, 2 $\frac{1}{2}$ -inch pipe is 50 percent more expensive than 2-inch pipe.

The stroke of the windmill is the distance that the plunger moves from top to bottom. A short stroke enables the windmill to begin pumping in light breezes but in stronger winds a long stroke allows for greater volumes of water to be pumped. Many gearboxes are designed to permit stroke adjustment, but the procedure usually takes more time than is convenient for frequent changes.

The submerged positive displacement pump or piston pump is generally the cheapest and most

versatile water mover. Above-ground pumps that pull water by suction are easier to install, but even the most efficient suction pump can create a negative pressure of only one atmosphere. This means that at sea level one can theoretically raise a column of water 32 feet by suction, but, as it turns out, friction losses and temperature changes render a suction pump incapable of pulling more than 22 to 25 feet.

#### THE PUMP ROD ASSEMBLY AND WELL SEAL

The linkage between the mill and the pump cylinder is called the pump rod. The pump rod begins with a shaft that extends from the gearbox, through a swivel. The swivel allows the upper rod to turn with the yaw of the machine without rotating the entire pump rod assembly. If the entire rod rotated, there would be a tendency for sections to unscrew, and also for the leathers to wear grooves in the cylinder. The shaft connects to the red rod. Generally a wooden 2-inch x 2-inch piece (ash is most commonly used), the red rod is designed to be the weakest link, or fuse, in the system. If anything goes wrong above or below it, the red rod will usually break, minimizing the costs of replacing more expensive or less accessible parts of the mill. The red rod extends downward and connects to the "polished rod" which passes through the "packer head" or "standpipe" and the "well seal" (Figure 2.9). The well seal is just that, a simple, expandable cap designed to keep dirt,

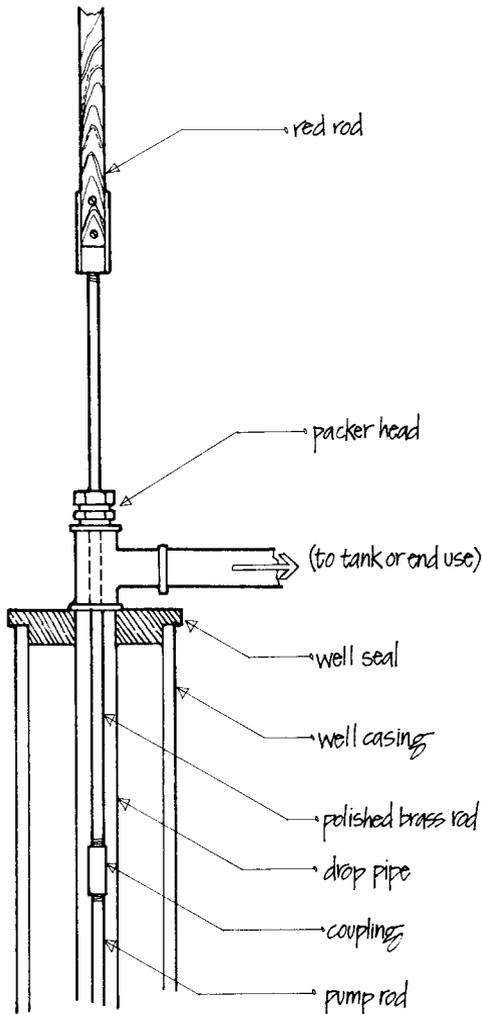

Figure 2.9. Detail of a windmill pump rod assembly.

insects, small animals, and other materials from falling into and contaminating the well and water supply. The polished rod is usually made of brass to reduce friction. Brass serves to reduce corrosion as well, which is important for a part that works in both air and water.

At the bottom of the pump rod assembly is the "sucker rod," which connects to the pump plunger and leathers. Shallow wells (less than 100 feet) will generally use cheaper, solid steel rods. Wells 100 to 250 feet deep need hollow "Airtite" rods for buoyancy, and those deeper than 250 feet need light, buoyant oak or ash rods.

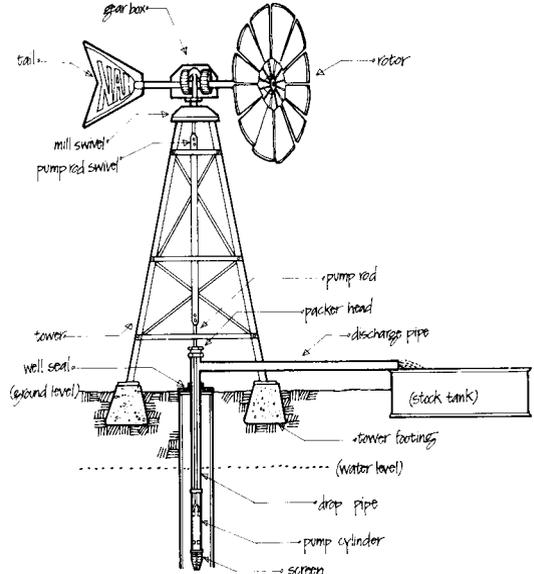
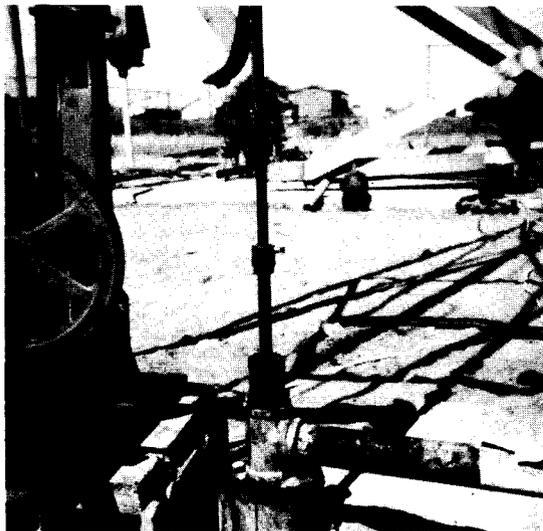

Figure 2.10. A windmill with a standpipe.

In shallow wells, a skinny rod (less than 7/16 inches in diameter) should not be used, as the rod will bend and snake on the downstroke, reducing the whole system's efficiency.

#### THE PACKER HEAD OR THE STANDPIPE

Once water is lifted, it is pushed through the drop pipe to the surface and out through a tee or discharge pipe. Depending on the pressure or distribution system, the water is either lifted into a standpipe (Figure 2.10) or diverted at a seal on top of the drop pipe, known as a packer head (Figure 2.11). The standpipe is used when a tank is not available but pressure is still desired. The



*Figure 2.11. A packer head, tee, and well seal.*

height of the standpipe depends on the desired pressure or "head" needed to transport the water. In freezing conditions, of course, the use of a standpipe would be foolish.

When water is being delivered to an elevated storage tank, or when a seal is desired over the drop pipe to guard against contamination or vandalism, a packer head must be used. The packer head is an inexpensive fitting that seals the drop pipe and prevents overflow. In freezing climates the packer head needs to be protected in an insulated, underground housing (Figure 2.12).

#### TRANSPORT AND STORAGE OF WATER

Whether water has been lifted by pushing with a positive displacement pump or by pulling with a suction pump, the next step is to build up the pressure and flow rate necessary to fulfill the pump's intended use. This section will describe the various options for transporting and storing water.

The three criteria of concern are (a) water pressure, (b) water flow rate, and (c) water storage capacity. Pressure is easily obtained by elevating the water, but if the pipe from the elevated tank to your kitchen is not large enough, you may have a trickling flow, or no flow at all, due to pipe friction. Similarly, pressure is virtually useless if you don't have the storage capacity to support your needs through windless periods. So it is the combination of these elements in concert that will

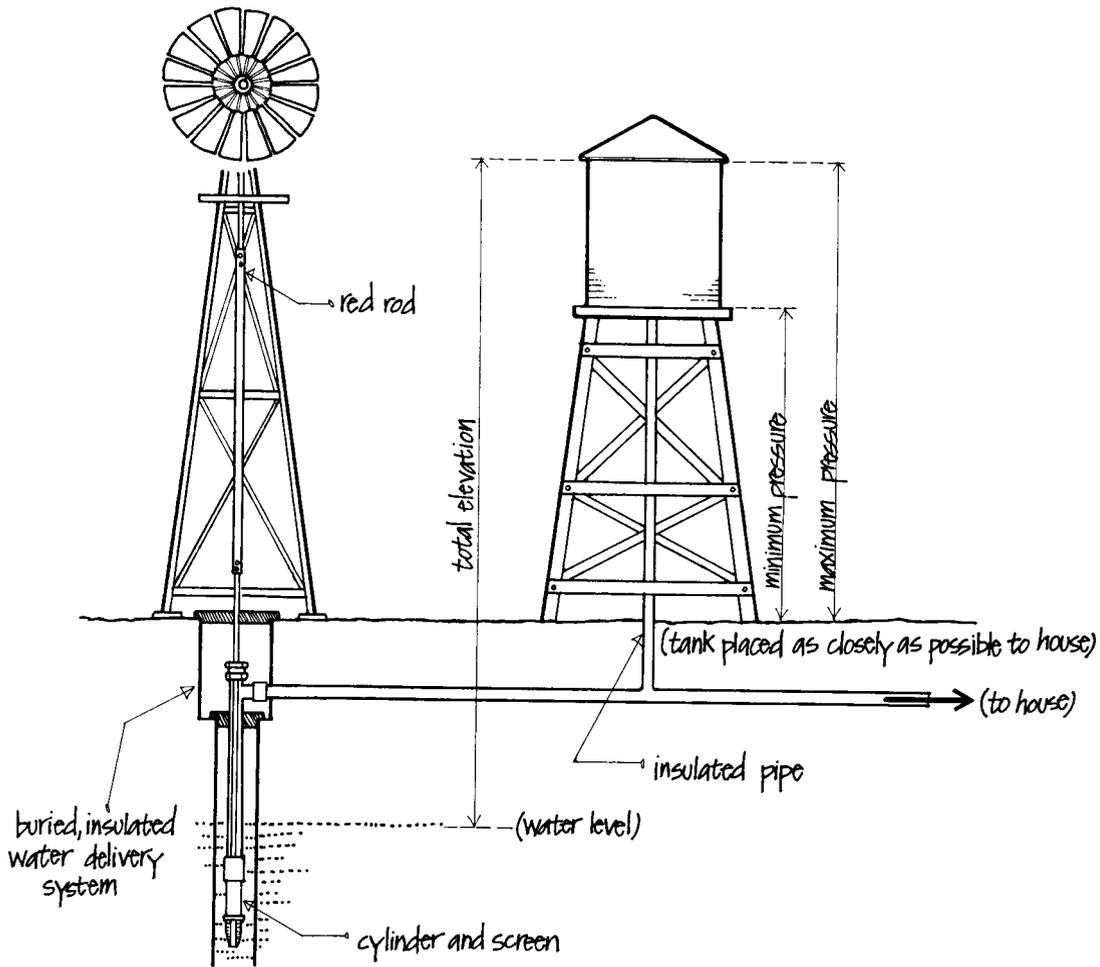

**Figure 2.12.** A complete windmill pressure system for freezing climates.

enable your WPWS to meet your needs.

The easiest way to build up water pressure is to raise the water to a greater height than the place of end use. This can be done by pumping it to a tank either on a nearby hill (Figure 2.13) or elevated on a tower (Figure 2.14). Every foot of elevation gives you about .43 pounds of pressure

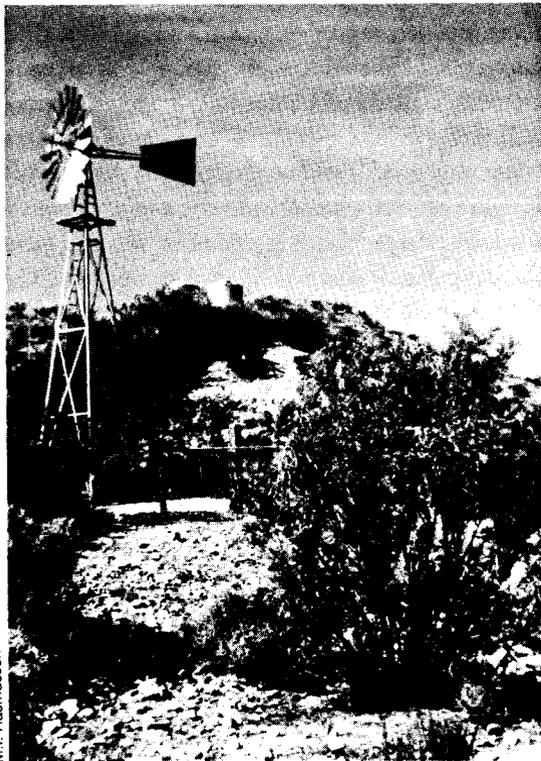

M.I. Rasmussen

*Figure 2.13. Using a local hill for the elevated storage tanks.*



Robert Sardinsky

*Figure 2.14. A windmill, storage, and pressure system, all on one tower.*

per square inch (psi). In other words, it takes 2.3 feet of elevation to get one psi. Most household applications require 18 psi, or about 41.5 feet of head.

The easiest way to pump water into a raised tank is to extend the drop pipe to a height greater than that of the top of the tank, i.e., a standpipe. The upper height limit of a standpipe is the height of the pump-rod swivel, or the top of the windmill tower. The disadvantages of this system are the elimination of the "safety fuse" quality of the red rod, and in addition, it is impossible to push water any higher than the standpipe. If an elevated tank is too expensive, but pressure is still desired, a standpipe can be used without a tank. However, standpipes offer very little storage capacity for windless periods. They also freeze easily. An elevated storage tank is a simple way to accommodate pressure and storage in one, and the large volume tends to resist freezing.

Elevating a tank can be made much easier if local topography cooperates. An empty 5,000-gallon capacity tank can be rolled up a moderately sloped hill by several people. If you don't have the convenience of a nearby hill or an already-existing elevated structure such as a sturdy barn, then a tank on a tower is your next option. Do not attempt this arrangement without consulting a structural engineer. Water weighs 8.3 pounds per gallon, so it is important to construct a very sturdy tank tower, especially in earthquake country. There are shortcuts — like gradually building up the tank from underneath with alternating railroad ties — but you should be very sure of what you are doing.

The most important rule in elevating storage tanks is to make sure that the tank bottom is at least a few feet above the height of the end use, so that adequate pressure will be maintained, even as the water level decreases. A simple rule of thumb in tank selection is to account for worst case demand. You can assume a daily rural per capita need of 50 gallons. In the Southwest, windmill people consider a ten-day stored supply safe. You'll wish you'd planned for excess storage capacity if a fire should break out. You should always plan for enough head to wet down your roof in a fire, even with a partially filled tank.

Tanks are not cheap, but a good wooden one can last for ages. Wooden tanks have been known to withstand subarctic conditions without sustain-

ing freezing damage. If you are concerned about freezing, paint your tank's south side black, and insulate on the north — or better yet, add a layer of fiberglass solar glazing to the southern side, leaving an insulative air space.

If elevation is a problem and you don't want the hassle of constructing an elevated tank and tower, you can always use the simple and proven scheme of moving water to a ground-level holding tank that is coupled to a pressure tank by a small electrical centrifugal pump. In this way, the windmill still performs the major work of bringing water to ground level and electricity is needed only for the relatively minor job of building up pressure. The larger the pressure tank, the less often the centrifugal pump will have to operate. The pressure tank should be close to the house to save on the amount of large-diameter pipe required to handle the outflow.

You can also design the windmill to pressurize a pressure tank without the use of an intermediary electrical pump, by oversizing the windmill for the job (see Chapter 3) and delivering water straight into the pressure tank. You'll want to include a pressure relief valve between the windmill and the tank so that the windmill does not overstress the pump rod or pump. Set the relief valve to exhaust pressure just below the tank's maximum capacity. The only disadvantage to this system is that you sacrifice storage capacity to obtain pressure — pressure tanks generally hold no

more than 50 gallons. This type of system should only be used where a backup power supply is available. One such system is described in Chapter 3. A submersible pump can also be connected directly to your WPWS.

Finally, pay attention to pipe friction when designing your system. Pipe friction is the resistance to water flow against the inner wall of the pipe plus the restrictions caused by valves and fittings. Friction of liquids in pipes increases as the square of the velocity. In other words, if water flow velocity is doubled, friction is quadrupled. The result is a decrease in pressure or "pressure drop." Pressure drop due to friction acts the same as pressure loss due to reducing the height of the water column. Because height (feet) and pressure (pounds) are related, standard friction tables, like Table 1, describe pressure drop in both terms. Note that friction increases significantly with slight increases in flow rate. Note also that there is less friction in plastic pipe than in steel pipe. Table 2 gives the equivalent foot of straight pipe for different types of fittings.

When you design your system, you can use these tables to determine whether the pipe length and diameter will create an acceptable friction-related pressure drop. Pipe friction is an important consideration in systems where the windmill is a good distance from the end use or where high flow rates are needed. In most cases, you can avoid pipe friction problems by shelling out the money

for larger diameter pipe, and/or designing to minimize changes in direction and the consequent fittings which further restrict flow rate.

A simple example will illustrate the pipe friction problem. Imagine that you are a rancher and need to fill a stock-watering tank 100 feet from your windmill. Along that run you need one gate valve and two 45-degree elbows. Being thrifty, you want to use the ¾-inch galvanized pipe from a pile you saved behind the barn. If the mill has a 10-foot standpipe, you can start with 5 psi and, let's say, a flow rate of 5 gallons per minute.

A look at Table 2 shows that the three fittings add the equivalent 2.5 feet of straight pipe to the system, for a total of 102.5 feet. At 5 gallons per minute, the pressure drop from Table 1 is:

$$\frac{102.5}{100} \times 2.72 = 2.8 \text{ psi}$$

This drop is unacceptable, because you are starting with a pressure capacity of only 5 psi. Thus, pressure drop should be kept below 2 psi, or your flow will be almost non-existent. A larger pipe is needed for the job. Looking at 1-inch pipe you find that the pressure drop is reduced to:

$$\frac{103.2}{100} \times .83 = .85 \text{ psi}$$

For this system, a loss of .85 psi is acceptable. Let's say you decide to also fill a tank 500 feet



Table 1. A Schedule-40 Pipe Friction Table

FRICITION OF WATER PER EACH 100 FEET OF NEW STEEL PIPE

Gallons per Minute	Gallons per Hour	<u>3/8-in. Pipe</u>		<u>1/2-in. Pipe</u>		<u>3/4-in. Pipe</u>		<u>1-in. Pipe</u>		<u>1 1/4-in. Pipe</u>		<u>1 1/2-in. Pipe</u>		<u>2-in. Pipe</u>	
		Feet	Pounds	Feet	Pounds	Feet	Pounds	Feet	Pounds	Feet	Pounds	Feet	Pounds	Feet	Pounds
1	60	4.30	1.85	1.86	.80	0.26	0.11								
2	120	15.00	6.45	4.78	2.06	1.21	0.52	0.38	0.16						
3	180	31.80	13.67	10.00	4.30	2.50	1.08	0.77	0.33						
4	240	54.90	23.61	17.10	7.35	4.21	1.81	1.30	0.56	0.34	0.15				
5	300	83.50	35.91	25.80	11.09	6.32	2.72	1.93	0.83	0.51	0.22	0.24	0.10		
6	360			36.50	15.70	8.87	3.81	2.68	1.15	0.70	0.30	0.33	0.14	0.10	0.04
7	420			48.70	20.94	11.80	5.07	3.56	1.53	0.93	0.40	0.44	0.19	0.13	0.06
8	480			62.70	26.96	15.00	6.45	4.54	1.95	1.18	0.51	0.56	0.24	0.17	0.07
9	540					18.80	8.08	5.65	2.43	1.46	0.63	0.69	0.30	0.21	0.09
10	600					23.00	9.89	6.86	2.95	1.77	0.76	0.83	0.36	0.25	0.11

FRICITION OF WATER IN EACH 100 FEET OF PLASTIC PIPE

Gallons per Minute	Gallons per Hour	<u>1/2-in. Pipe</u>		<u>3/4-in. Pipe</u>		<u>1-in. Pipe</u>		<u>1 1/4-in. Pipe</u>		<u>1 1/2-in. Pipe</u>	
		Feet	Pounds	Feet	Pounds	Feet	Pounds	Feet	Pounds	Feet	Pounds
1	60	1.14	.494								
2	120	4.10	1.770	1.04	0.450	0.32	0.140				
3	180	8.65	3.740	2.21	0.957	0.68	0.294				
4	240	14.60	6.410	3.74	1.620	1.15	0.500	0.304	0.131	0.144	0.062
5	300	22.20	9.610	5.66	2.450	1.75	0.757	0.460	0.199	0.218	0.094
6	360	31.20	13.500	7.95	3.440	2.45	1.060	0.649	0.281	0.305	0.132
7	420	41.50	17.900	10.60	5.840	3.30	1.430	0.860	0.372	0.406	0.175
8	480	53.00	22.900	13.50	8.830	4.16	1.800	1.100	0.476	0.520	0.225
9	540	66.00	28.600	16.80	12.400	5.20	2.250	1.400	0.590	0.650	0.281
10	600	80.50	34.800	20.40	16.500	6.31	2.730	1.670	0.723	0.785	0.339

Source: Carter, Joe. "Using Water Pumping Windmills: Part III - Low Pressure Water Systems," *Wind Power Digest*, 16 (Summer, 1979): 8-13. Used with permission.

Table 2. Equivalent Feet of Straight Pipe for Different Fittings

	Size of Fitting, Inches									
	½ in.	¾ in.	1 in.	1¼ in.	1½ in.	2 in.	2½ in.	3 in.	4 in.	5 in.
90° Ell	1.5	2.0	2.7	3.5	4.3	5.5	6.5	8.0	1.0	14.0
45° Ell	0.8	1.0	1.3	1.7	2.0	2.5	3.0	3.8	5.0	6.3
Long sweep ell	1.0	1.4	1.7	2.3	2.7	3.5	4.2	5.2	7.0	9.0
Close return bend	3.6	5.0	6.0	8.3	10.0	13.0	15.0	18.0	24.0	31.0
Tee—straight run	1.0	1.4	1.7	2.3	2.7	3.5	4.2	5.2	7.0	9.0
Tee—side inlet or outlet	3.3	4.5	5.7	7.6	9.0	12.0	14.0	17.0	22.0	27.0
Globe valve open	17.0	22.0	27.0	36.0	43.0	55.0	67.0	82.0	110.0	140.0
Angle valve open	8.0	11.0	14.0	18.0	22.0	27.0	33.0	41.0	53.0	70.0
Gate valve fully open	0.4	0.5	0.6	0.8	1.0	1.2	1.4	1.7	2.3	2.9
Gate valve half open	8.0	11.0	14.0	18.0	22.0	27.0	33.0	41.0	53.0	70.0
Check valve	4.0	6.0	8.0	12.0	14.0	19.0	23.0	32.0	43.0	58.0

Source: Carter, Joe, p. 10. Used with permission.

away, at the same elevation. The total pressure drop with 1-inch steel pipe will be:

$$\frac{500}{100} \times .83 = 4.15 \text{ psi}$$

This pressure loss is unacceptable. You will need to go with a 1¼-inch pipe which results in a 1.1 psi drop. These examples reaffirm my point about thinking through the entire system before you begin purchasing parts. Look ahead to future or desired uses.

We'll return to pipe friction concerns in the next chapter when we look at specific home systems.

Before discussing how to select the proper mill for specific circumstances, I should mention that a number of nonconventional water-pumping systems are also available for special situations. For instance, it isn't always easy to locate the windmill directly over the well. Sometimes the well is in the basement of a house, and drilling a new one is prohibitively expensive. Some people may choose to pump from a pond or other natural body of water. And many situations will be characterized by beautiful, steady winds at one location, but a shallow (and lower cost) well at another spot. How can a windmill service these

conditions in light of what we've explained? As this book will attest, windmillers are limited only by lack of imagination. "Scrounge-ability" and a little daring will go a long way. For example, I mentioned earlier that pumping by suction is possible (Figure 2.15 and 2.16). This method is feasible for pumping horizontally from one loca-

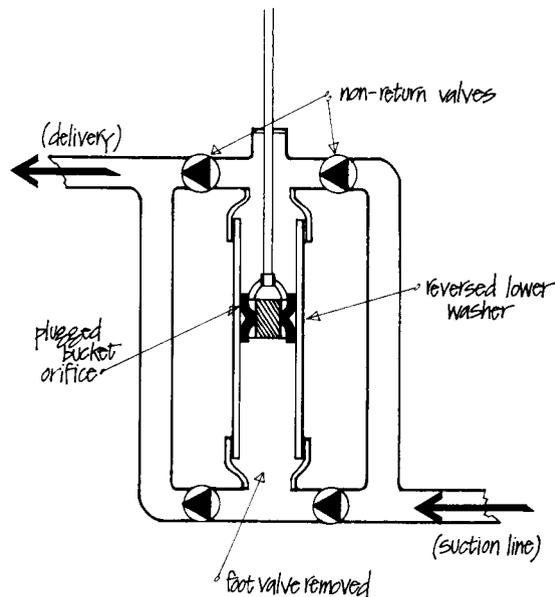

Figure 2.16. A double-acting suction pump.

tion to another (see Figure 2.17) as long as the connecting joints are tight and the water is not more than 25 feet (at sea level) below the pump depth. Again, you'll have to account for some friction, here, but I've pulled water over 200 feet from a nearby river 10 feet below my pump.

Another ingenious way to cover horizontal displacement is described in Figure 2.18 where a well is already located beneath a house. This system operates by cable and uses weights to "push" the pump leathers in the "downstroke." It results in dependable operation, and the owner never has to move water outside the house.

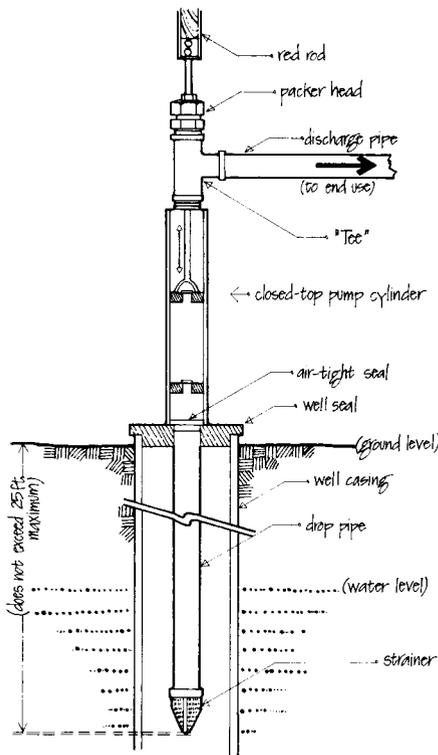

Figure 2.15. Suction with a positive displacement pump.

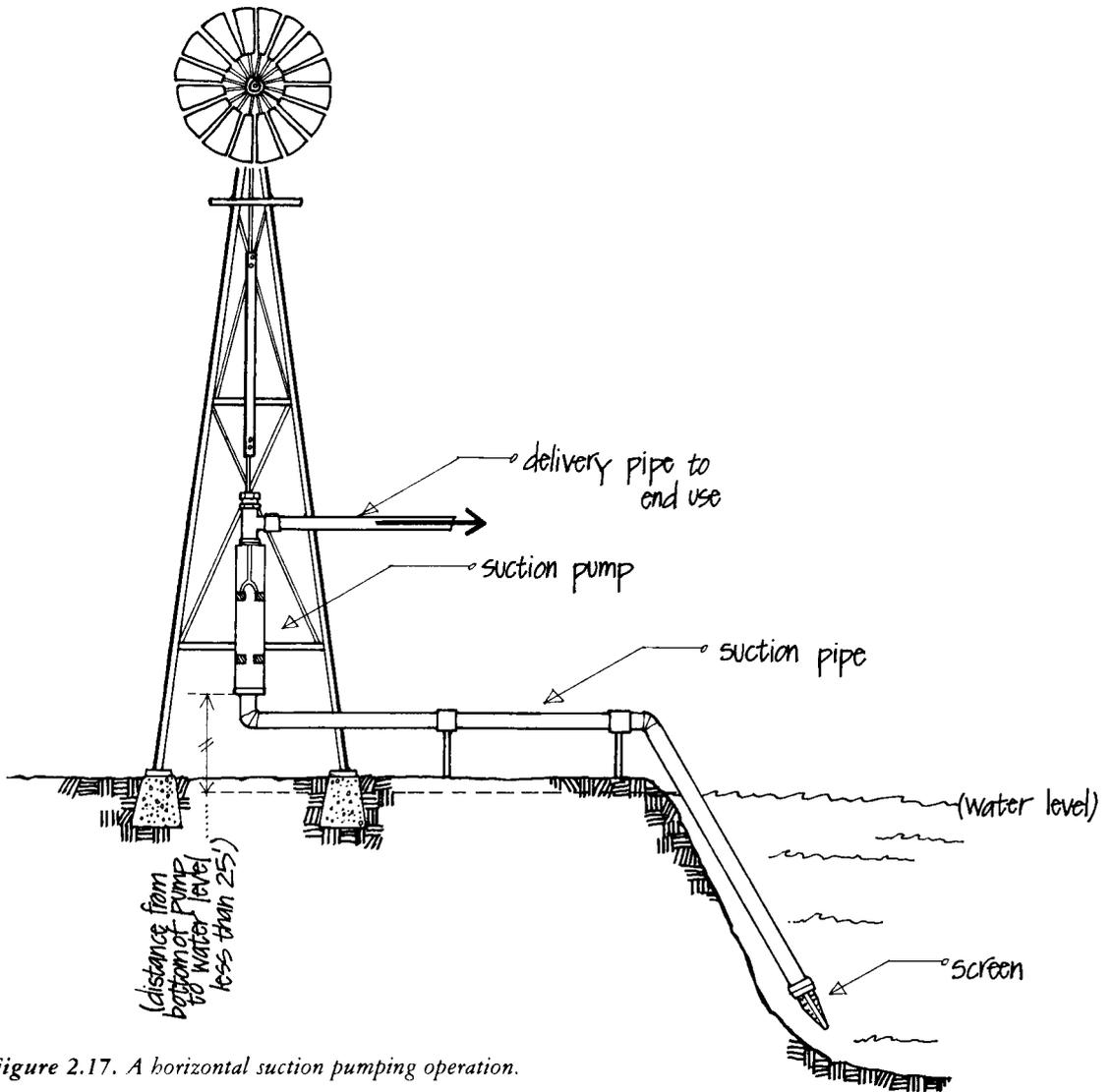

Figure 2.17. A horizontal suction pumping operation.

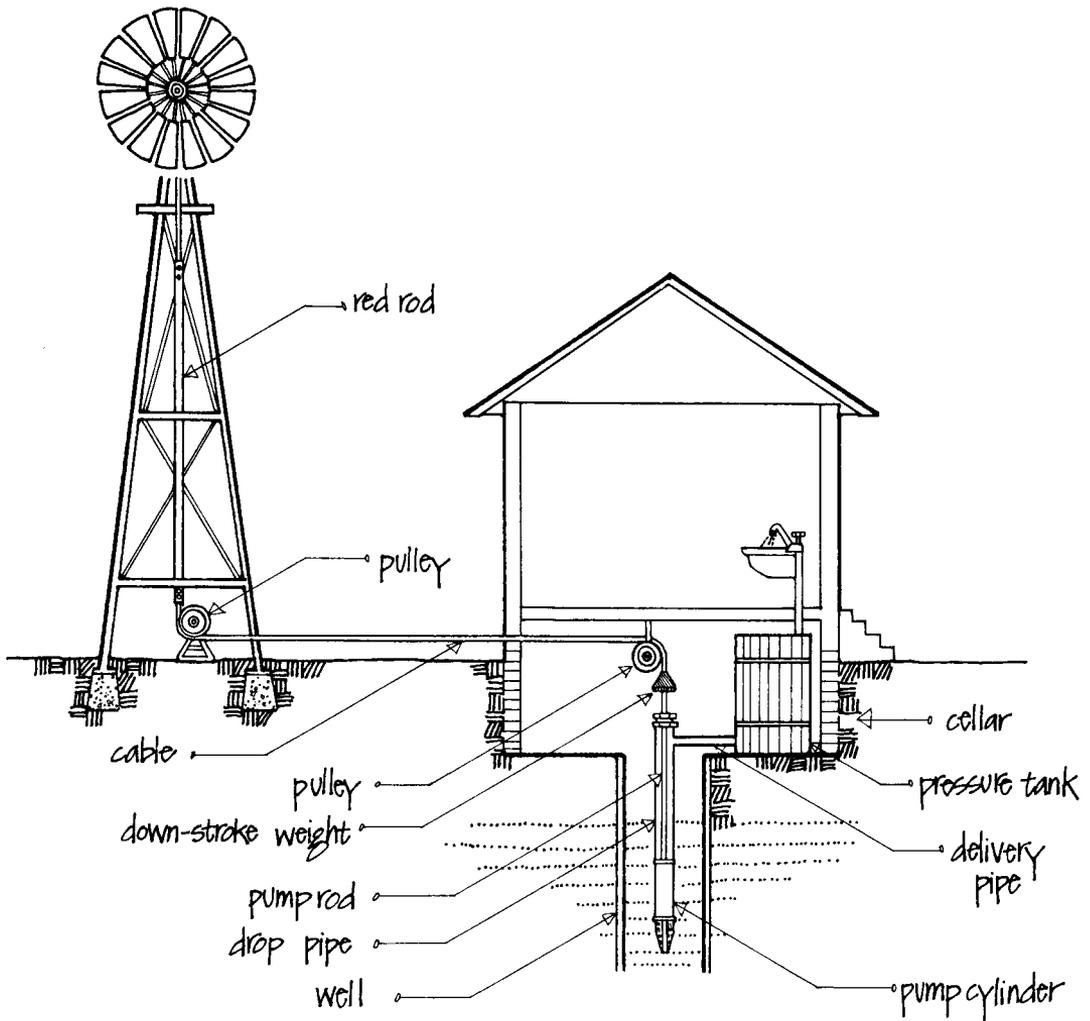

Figure 2.18. An offset pumping system for already-existing cellar wells.

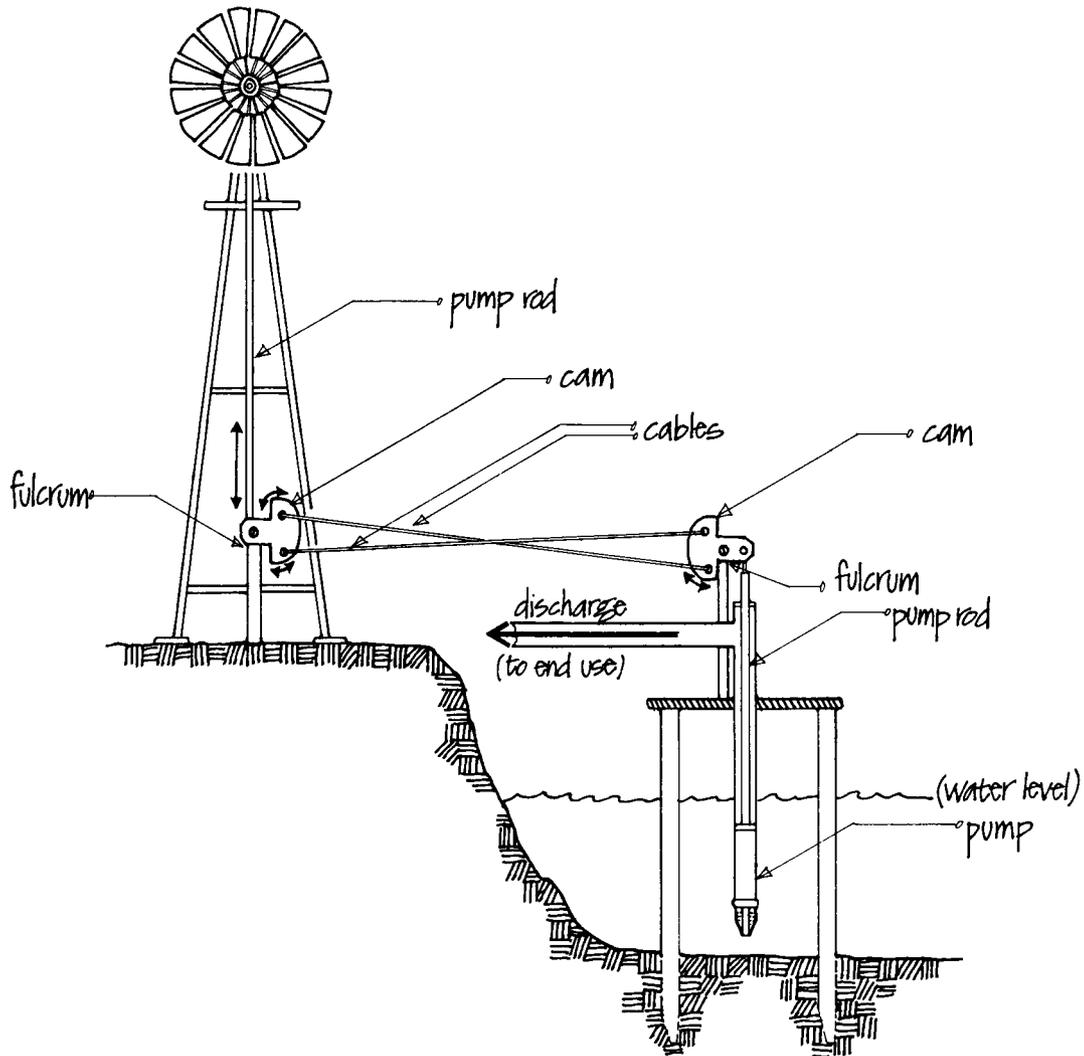

Figure 2.19. An offset WPWS.

There's also the clever reciprocating fulcrum system that has been used in this country by Amish farmers, making use of water wheels (Figure 2.19). This system is ideal for pumping from natural water bodies, but careful precautions must be taken if children are nearby — the cables can cut like scissors if you get caught in them.

Finally, cost-effective backup systems are available. Besides the earlier-mentioned strategy of combining an electric submersible pump with a windmill pump, above-ground devices which can operate in remote sites are available from a number of companies. Electric or gasoline-powered "pump jacks" (See Figure 2.20), when attached to your pump rod, can provide easy back-up in a pinch. A good, reliable backup system costs from \$500 to \$800. A list of manufacturers is included in the Appendix.



*Figure 2.10. A commercial pump jack.*

# Is a Windmill for You?

DETERMINING WHETHER YOUR SITE OR BUDGET CAN ACCOMMODATE A water-pumping windmill system is a fairly straightforward procedure. The process involves (a) assessing potential legal restrictions, (b) determining your available wind resource, (c) determining your current and future water use patterns, and (d) choosing the appropriate system for these circumstances.

## POTENTIAL LEGAL RESTRICTIONS

Legal considerations are not likely to affect rural or farm dwellers, but in suburban or urban sites, legal restrictions can cause your entire project to fall flat. Height restrictions are the typical concern as are neighbors' complaints about aesthetics. At least one town in New Hampshire has passed ordinances requiring that windmills be built so they will not strike a neighbor's property if they fall.

In many parts of the country it is illegal to drill a well without special permission. In one situation here at The New Alchemy Institute, a project was delayed six months by permit and appeals hearings, application for a variance and other legal requirements. When we got down to the wire, we learned about a loophole that allowed us to call the machine a TV antenna and bypass the whole permit process. The laws, of course, will vary with each town.



By the way, television interference is not a problem with water-pumping windmills, as is sometimes the case with metal-bladed wind generators. While the high-solidity, metal-bladed water pumper appears to TV waves as a stationary metal disc, the water pumper's blade motion is invisible to the TV waves.

The easy way to avoid legal problems or costly delays is to visit your town or city hall and your building inspector before you begin the project. Remember, too, that it is possible to have laws changed to fit the times.

### ASSESSING YOUR WIND RESOURCE

Your next step is to determine just how good the winds are at your site. Windmills simply are not appropriate energy savers for every site. Your greatest concern is the average winds during the period of your greatest water need. For example, if you are planning to use the windmill for irrigation or outdoor aquaculture in New England, you will be most interested in average August winds. Commercial windmills are not cost effective in average winds below 7 or 8 mph, and it's hard to amortize even low-cost home-built machines in winds less than 5 or 6 mph.

Remember the basic rule of thumb that a wind machine should stand at a minimum of 25 feet above any obstructions (trees, buildings, and so forth) within 100 yards. This is the height at which you will want to measure your average

winds. The available power in the winds varies as the cube of the wind speed. This equation looks like  $P = KV^3$ , where  $P$  = wind power,  $V$  = wind velocity, and  $K$  depends on size and efficiency of the system. If you double your wind speed, you will get a corresponding eightfold ( $2^3$ ) increase in power. This means that a site with 12.5-mph winds has double the available power of one with 10-mph winds.

There are many strategies and types of equipment for wind "prospecting." Equipment costs for a good analysis can range from \$65 to \$600, although rentals are available. Some states now have loan programs — check with your state energy office.

In my opinion it is not necessary to conduct a thorough one-year wind analysis for a WPWS, especially if you follow the minimum height rule. My recommendation is first to try talking to weather station personnel or weather buffs in your area. If a radio station or airport is close by and there are no obvious discrepancies between their site and yours (such as a coastal or mountain top location), you may be able to make do with their data base for your situation. Remember, their data is acceptable only if you raise your windmill high above all objects on your site, and in the clear windstream. On some sites a difference of only 100 yards may make a large difference in available wind. A streamer on a 25-foot pole will enable you to check many locations quickly.

If you don't feel comfortable making an extrapolation between sites, a relatively low-cost approach is to buy or rent a wind odometer for a few months of measurements. A wind odometer, like your car odometer, measures the number of miles of wind that run past your site. If you divide that figure by the number of hours the odometer has run you will obtain the useful mph figure. For instance, if your odometer registers 360 miles of wind in a 24-hour period, you find by dividing that the average wind speed for the day was 15 mph. Mount the odometer on a telescoping tower available from Radio Shack or your local wind system dealer. A complete wind odometer and telescoping tower will cost from \$200 to \$350, installed.

If you make measurements at regular intervals (once daily) for the three months in which your water needs are greatest, you will have an excellent data base for comparison with nearby weather stations. Take the monthly averages on your site and compare them to the weather station's ten-year average for the same months. Divide your average by theirs to obtain a correlation factor. To find your annual average windspeeds, multiply the weather station's annual average by your correlation factor.

### DETERMING YOUR WATER USE

Determining how much water your WPWS will need to provide is the easiest job of all. Most

	<u>Your Site</u>	<u>Weather Station</u>
June	11 mph	11.5 mph
July	12 mph	12.7 mph
August	11 mph	11.6 mph
Average	11.3 mph	11.9 mph
Correlation:	Your Site	$\frac{11.3 \text{ mph}}{11.9 \text{ mph}} = .95$
	Weather Station	

Weather station's annual average:

$$12.1 \text{ mph} \times .95 = 11.5 \text{ mph (your annual average wind speed)}$$

wind system dealers assume a rural *per capita* average of 50 gallons per day, and an urban/suburban *per capita* average of 100 gallons per day. Again, you need to focus on the period in which your water need is greatest and you should be conservative in all your calculations. Add up all the water users in your house — people, animals, lawns, and gardens (see Table 3). Add in a few hundred gallons for that dry August week when the inlaws are visiting and don't forget the kids' car wash business. Your ability to adequately predict future water use will save you lots of money by enabling you to size your wind machine properly at the beginning. Your ability to adequately predict the pattern of use (for example, what times of the day is water use greatest?) will save the cost and trouble of having to upgrade your storage capacity at a later date. For instance, if you need 600 gallons at dinner time, and 600 gallons to feed the animals and bathe the children shortly after, your 1,000-gallon storage tank will fall

**Table 3. A Table of Typical Water Usage**

Type	Gallons
Milking cow, per day	35
Dry cow or steer, per day	15
Horse, per day	12
Hog, per day	4
Sheep, per day	2
Chickens, per 100, per day	6
Bath tub, each filling	35
Shower, each time used	25–60
Lavatory, each time used	1–2
Flush toilet, each filling	2–7
Kitchen sink, per day	20
Automatic washer, each filling	30–50
Dishwasher	10–20
Water Softener	up to 150
¼-inch hose, per hour	300
Other uses, per person per day	25

(Source: The Aermotor Company)

short of helping you if the wind is not blowing. Of course, water conservation will also be an important cost-saving feature. We will discuss such savings in the next section.

You also need to determine the minimum water pressure for your home. Physics tells us that each foot that water is elevated yields 2.3 pounds of pressure (1 ft. = 2.3 psi). The inverse of this

relationship says that each pound of pressure is equivalent to lifting the water .43 feet (1 psi = .43 ft). Dishwashers and other appliances generally require 18 psi. This means that water must be lifted 41.4 feet to meet the appliance's requirement. If you have a shower on the top floor and a desired shower pressure is 15 psi, then use the height equation (1 foot = .43 psi) to determine the pressure required for that height and add it to the 15 psi to determine the total required pressure. For example, if the shower is 25 feet above the ground, you would need 25 divided by 2.3 ft/psi pressure, or roughly 11 psi. Add this to the desired 15 psi pressure and you need a WPWS pressure capacity of 26 psi. In other words, your WPWS must be able to lift water 26 psi x 2.3 ft/psi, or 60 feet. Of course, this figure is not adequate, because we've neglected to include the friction loss in transport (pipe friction), which must be accounted for, as detailed in "Transport and Storage of Water" in Chapter 2.

Putting things in perspective, obtaining a stiff shower jet on a second floor may be much less important than being able to hose down your roof quickly in case of fire. This capability will demand a margin for pressure and flow, not to mention hoses and taps you can connect to quickly. If you don't have a hill available for your water tank, and if your calculations imply an impractical water tower height, you're in for compromises (Figure 3.1).

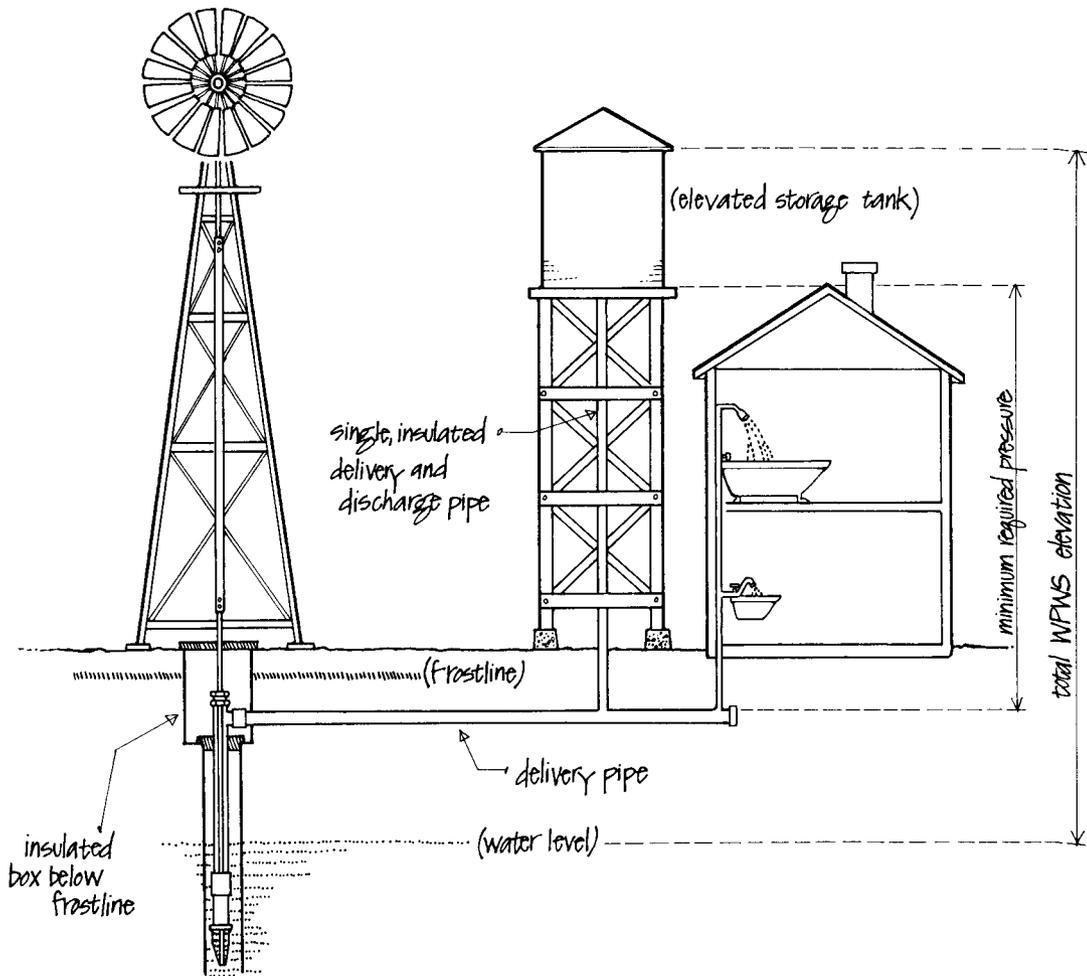

Figure 3.1. Pressure considerations in a domestic windmill application.

Pressure tanks can give the head you need for an upstairs shower, but not cheaply with reliable capacity. If you currently use a water-saving flow restrictor on your shower, you've already learned to shower at pretty low pressure. You might decide to set up for showering downstairs only, have a bathtub upstairs, and incorporate a quick-starting gasoline pump to boost pressure for fire-fighting. If so, an attic cistern may fulfill your domestic pressure needs — but be sure to consider structural loads and bearing walls.

### SELECTING THE WPWS FOR YOUR NEEDS

Now that you've gathered all this requisite information, you are ready to pick the system for your needs. In this section, we will discuss selecting and sizing the appropriate wind machine and pump combination. We will consider practical storage options in the next section when we discuss two complete home systems.

You now have the information to answer four fundamental questions:

1. How much wind do you have? (What is the average wind speed during the period of greatest water use?)
2. How much total lift (elevation) do you require? (What is the total distance from your water table [at the driest time of the year] to the highest point of end use, including compensation for head losses due to friction

and allowing for an adequate working pressure head?)

3. How much water volume do you need? (What is the most water you will need at any given time?)
4. How fast do you need water delivered? (At what rate is water required during the period of maximum use?)

The commercial windmill companies all try to make it easy for you to answer these questions. And, generally speaking, they succeed, although some very important cautions must be exercised.

Dempster, Aermotor, and Baker provide charts, like Table 4, listing windmill/pump capacities. Table 4 shows that you can combine windmill and pump cylinder sizes to devise a system capacity that meets your needs. The windmill size refers to the diameter of the windmill rotor; it indicates both the amount of available power and the length of the machine's pump stroke. The cylinder size describes the pump's inner diameter (the plunger diameter); it determines the volume of water the windmill will lift, depending on the windmill's stroke length. Elevation refers to the total lift from water table to end use including the pressure required at the end use. Gallons per hour (gph) is the desired flow rate.

For instance, we can see from the chart that a 6-foot diameter wheel, when coupled to a 2-inch diameter pump cylinder, enables a pumping

**Table 4. A Commercial Windmill Pumping Capacity Chart.**

Maximum Elevations in Feet and Capacities in Gallons Per Hour (gph)

**SIZE OF WINDMILL**

Cylinder Size (in.)	6 Ft.		8 Ft.		10 Ft.		12 Ft.		14 Ft.		16 Ft.		20 Ft.	
	Elev.	gph	Elev.	gph	Elev.	gph	Elev.	gph	Elev.	gph	Elev.	gph	Elev.	gph
1½	120	115	175	119	260	103	390	121	570	103	920	138	1,200	162
2	95	122	140	135	215	117	320	137	456	118	750	157	1,026	184
2¼	77	165	112	170	170	148	250	174	360	149	590	199	903	232
2½	65	204	94	210	140	182	210	214	300	184	490	245	896	287
2¾	56	247	80	255	120	221	175	259	260	222	425	296	692	347
3	47	294	68	303	100	263	149	308	220	264	360	353	603	413
3¼	39	345	55	356	87	308	128	362	186	311	305	414	496	485
3½	34	400	49	412	75	357	111	420	161	360	265	480	390	562
3¾	29	459	42	474	65	411	96	482	141	413	230	551	310	646
4	27	522	38	539	57	467	85	548	124	470	200	627	252	734

NOTE: Table is based on a 15-mph wind.

For 10-mph wind reduce capacities by 38 percent.

capacity of 122 gph to an elevation of 95 feet. Note what happens when we move to a larger (10-foot) wind rotor with the same pump. Our lift (elevation) capacity has increased, but our pumping rate has decreased. While the larger wind machine puts out more power *per stroke*, the larger wheel turns more slowly and consequently pumps fewer strokes. The result is a poor match, that is, a decreased pump rate. To obtain a better match, a larger pump should be employed for the bigger mill.

Charts like this one are generally useful if you consider three critical points:

1. Windmill/pump combinations can be described in terms of horsepower (hp) capacity, or in foot-pounds (ft-lb). Foot-pounds represent the forces required to move a weight (lb) over some distance (ft). In the case of the windmill and pump, ft-lbs represents the lifting of volumes of water (lb) times a certain maximum desired elevation (feet). The windmill companies attempt to make the system's ft-lb capacity easy to understand by breaking it down in the two component columns, elevation capacity and gph capacity. However, in practical application, these figures

should be used only as reference points. The real windmill will not perform as shown on paper, and in some cases, height and flow rate figures will vary greatly from the predicted figures. The thing to remember in your practical planning is not to cut corners too tightly. If you need precisely 115 gallons per hour and your lifting need is 210 feet, chances are that the combination of 10-foot windmill and 2-inch pump are not going to meet your needs. You'd be better to go with the next larger windmill.

2. The limiting factor in choosing different pump sizes will be your well diameter, unless you can use a pump to suction water from above-ground. On Cape Cod and in most parts of the country, slight increases in well diameter can result in tremendous increases in the well cost per foot. Where I live a 3-inch cased well costs \$8 per foot and a 6-inch cased well costs \$26 per foot. The minimum well diameter for a 2-inch diameter pump is 3 inches, and the minimum well diameter for a 3-inch pump is 4½ inches. There are special types of pumps which can fit in tube wells (measuring 2 inches in diameter) called Eureka pump cylinders. Also, it is feasible to pump the same water volume from a smaller, less expensive well by getting a long, skinny pump and using a mechanical advantage to increase the windmill's stroke length. Generally, however, it is less costly to sacrifice the ideal windmill/pump match by using the size pump that fits your pres-

ent well and increasing the windmill diameter as needed.

3. The most important caution of all when using these charts is to be aware that the windmill companies all base their capacity charts on 15-mph average wind speeds. The number of places in the country where 15-mph averages can be achieved at economical tower heights (under 90 feet) are very few, especially if you consider that you are primarily concerned with the period of greatest water need, which is usually the summer. In most of the northeast, summer is the least windy time of year, the period in which wind speeds are below the annual average for the same site. We can expect large differences in available power with deviations even a few miles per hour from the 15-mph average. In practice, a 12-mph wind results in a 20 percent reduction of the predicted system capacity. And a 10-mph average wind results in a 38 percent decrease.\* The importance of knowing your winds and picking a larger windmill than the one the chart recommends for your site is critical. You'll be sorry if your machine delivers only one-third of the time in your variable winds, and needless to say, your payback period will be greatly extended.

\*If you work it out, reductions from 15 mph to 12 and 10 mph would give, respectively, 49 percent and 70 percent reductions in cube-law wind energy. Average pumping reductions for water pumpers are not nearly so great since water pumpers are designed for optimum efficiency in relatively light winds, while their efficiency suffers drastically in strong winds.

## REAL-LIFE APPLICATIONS

We will return to the subject of sizing windmill systems to meet your needs in the discussion of the Sailwing windmill. Calculations of horsepower (or ft-lbs) are more important with this and other homebuilt designs, as capacity tables are not available. For now, it is useful to consider some practical applications based on what we already have discussed. Let us deal with two examples in terms of technical options. We'll focus on economics in Chapter 6.

### SAMUEL'S HOUSE

Samuel has a house and barn in southern New Hampshire. He would like a WPWS for his family's year-round use, for his animals, and for modest summertime watering. His winds are excellent, averaging roughly 12 mph in August, the least windy time of the year. Looking ahead a few years, he can anticipate a maximum need of 1,000 gallons per day. He has no real pressure needs aside from his kitchen and downstairs bathroom use — 10 to 15 psi is adequate. At breakfast, the time of maximum use, he would ideally like to have a flow rate of 4 to 5 gallons per minute for about an hour.

Samuel's well is the original farm well from the early days. It is 6 inches in diameter, clean, and has an excellent recharge rate. Water is never more than 50 feet below the surface (Figure 3.2).

His house is on top of a hill (thus the good

winds) and he has no local higher location on which to set his tank for storage pressure. He does, however, have a sturdy old post-and-beam barn nearby, and the upper level is well above the ridge of his house. With a local carpenter's advice, he has determined that the barn rafters could easily support up to 4½ tons or roughly a full 1,000-gallon tank. A 5-foot tank at this height (35 feet above the ground) plus 60 feet below ground to the pump (water depth plus 10 feet submergence) would equal a total elevation of 100 feet. Samuel knows of a 1,000-gallon wooden water cistern owned by an old timer down the road. The old timer thinks the boy is crazy. "Windmills are a thing of the past," he grumbles, "but I'll let you have the tank for \$250." A fair price — Samuel buys the tank, dismantles it, and reassembles it atop the barn.

The barn is 100 yards downwind from the well, so Samuel cuts corners and chooses a 60-foot tower which puts the center of the windmill 15 feet taller than the barn peak.

Samuel has decided to use a commercial windmill. He knows he has good winds (12 mph) and that he must pump at least 170 gallons per hour during the least windy time of the year. A look at the Windmill Pumping Capacity Chart (Table 4) indicates that an 8-foot mill with a 2¼-inch pump could do the job if his winds averaged 15 mph. But his 12-mph breeze means at least a 20 percent capacity reduction. Besides, a 2¼-inch pump



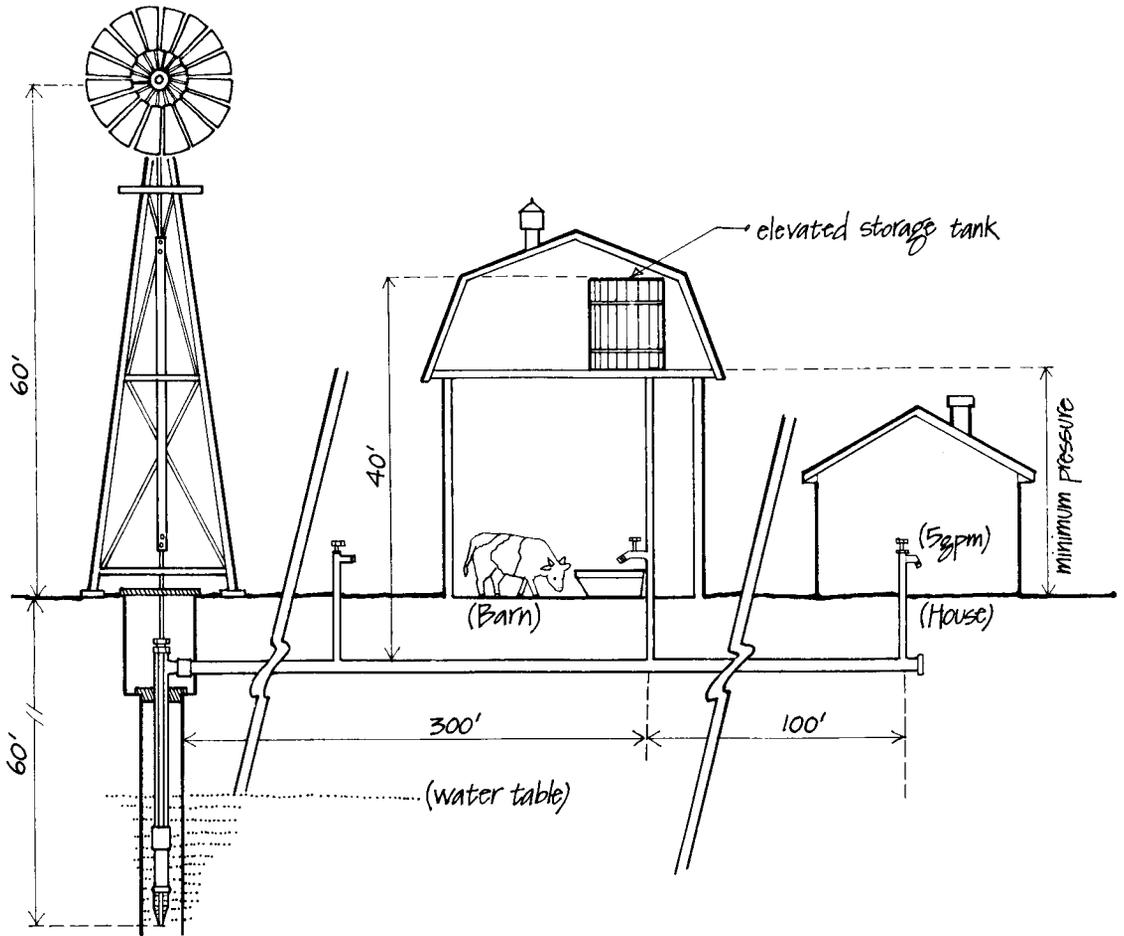

Figure 3.2. Samuel's site.

would mean he'd need 50 feet of 2½-inch drop pipe to replace his pump leathers without pulling the entire length of pipe. The same 8-foot mill with a 1⅞-inch pump is also too small, so he looks at a larger windmill. The 10-foot windmill with the same 1⅞-inch pump can lift to an ample elevation (256 feet), but the flow rate (140 gph) is low. On the other hand, he reckons, such a large rotor with that small pump means the windmill will start up in lower winds, and if he can cut down a bit on early morning use and rely more on his storage, he can probably sacrifice a few gallons per hour. This adjustment saves him the cost of a larger windmill (and a heavier tower) plus 50 feet of large-diameter (expensive!) drop pipe.

Now it's time to work out his pipe distribution system. His windmill and well sit 300 feet from the barn and 400 feet from the house. Since his storage tank holds much more water than he uses at one time, his desired 4- to 5-gpm flow rate applies only to the delivery from tank to house. Similarly, he can tolerate a friction loss of 5 psi to the tank before he gets worried. Looking at the friction chart for plastic pipe (Table 1), he is delighted to find that inexpensive ¾-inch pipe will lose less than 5 psi and will still deliver 4 gallons per minute from the windmill to the barn. From the barn to the house, however, he does require a 4- to 5-gpm flow and does not want to sacrifice much pressure. More expensive, 1-inch pipe from the barn to the house will lose him only .76 psi at

5 gallons per minute.

Samuel now has a simple, low-maintenance system and he can expect a payback in roughly eight years. If he is nervous about running short, a simple backup pump or a pump jack would do the job.

### BARBARA'S HOUSE

Barbara lives on Nantucket where the winds are exceptional. She has a modern house with many conveniences including an electric centrifugal pump and a pressure tank water system. However, a few years ago, lightning burnt out the system and she was without water for two days. She replaced the pump but her new one seems to need a lot of repairs. She would like to cut down on her electrical use and is interested in a wind machine, but she does not have quite enough money for a wind generator. Besides, she is thrifty and wants to wait "... a few years until the wind-electric generators are less expensive."

Barbara's present well is under her house. It is a 2-inch cased well and would not allow for a very large windmill pump. Besides, she does not want to give up her present well system — it is a perfectly good backup. Her water table is shallow — only 18 feet. A new 3-inch cased well will cost her only \$150.

Town ordinances prevent Barbara from elevating a water tank on her property. That is all right, because she does have the pressure tank.

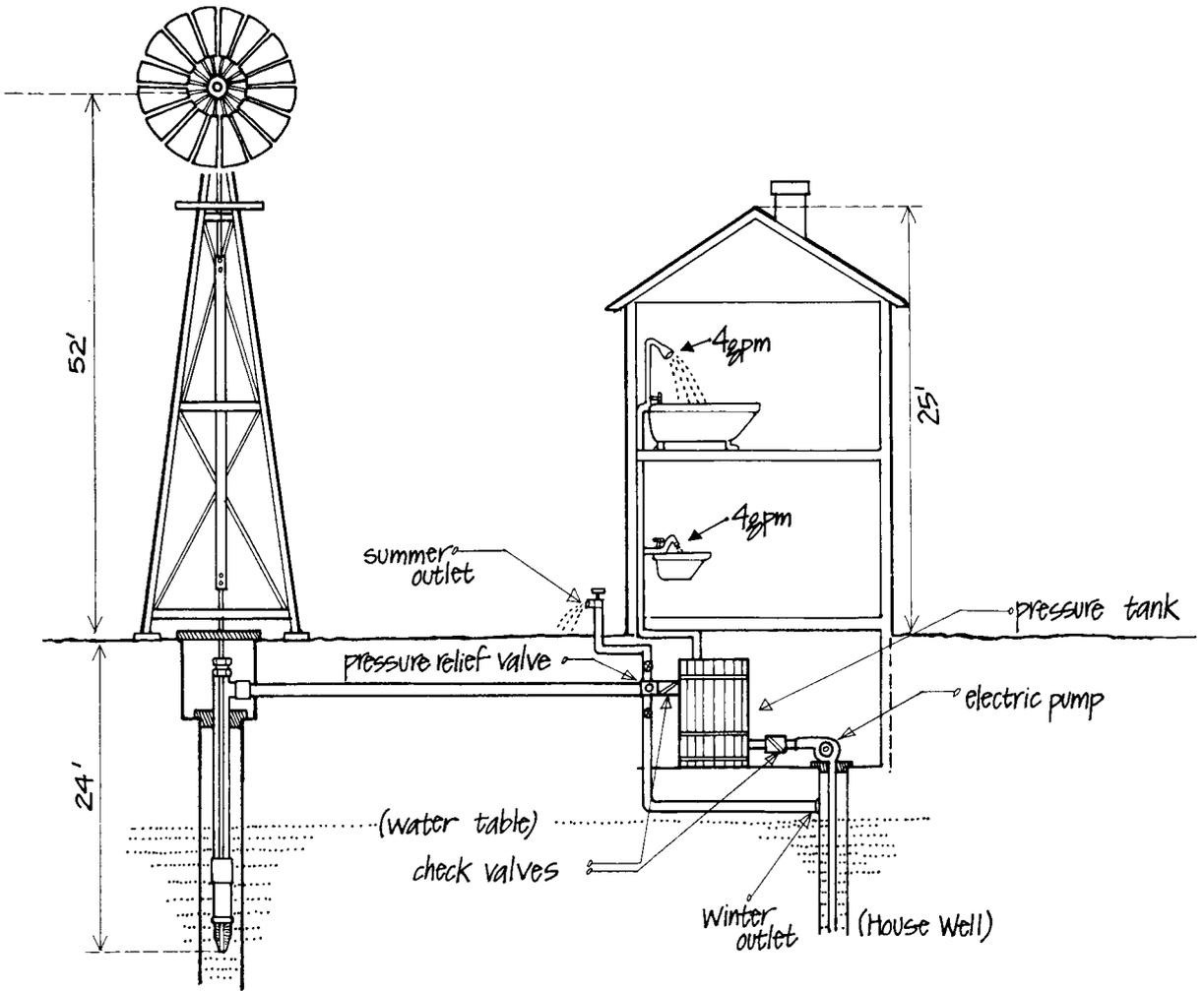

Figure 3.3. Barbara's site.

However, it stores only 50 gallons. Her site's exceptionally high winds (14 mph) reduce her storage need, and her electric pump will be able to help in a pinch.

The maximum pressure requirement for this job is 30 psi, or 71 feet. The desired flow rate is 3 gpm. From the Windmill Pumping Capacity Chart (Table 4) we determine that an 8-foot mill with a 2½-inch pump will meet her system's requirements.

Because her house stands 25 feet tall, she selects a 50-foot tower and builds her well and windmill 20 feet from the house (Figure 3.3). This cuts down the water transport distance, and saves on pressure losses due to friction. Thus, she can use inexpensive 1-inch plastic pipe, losing only ½ psi in delivery to the house.

The delivery pipe connects directly into the pressure tank. However, to avoid straining the windmill and pump when the pressure tank is full, we install a pressure relief valve between the windmill and the tank. The valve is set to release excess pressure before the system's capacity is attained. In the summer, the excess spills into her garden and drip irrigates her fruit trees. In the winter, the water goes back into the water table via the basement well.

We now have an elegant system that combines a reliable, energy-saving windmill with an elec-

tric backup for windless periods. When the wind is blowing, Barbara can turn on her faucet and rely almost completely on the windmill for normal use. If she requires a large volume of water over a long period, both windmill and electric pump work, and in windless periods the electric pump does the job. The costs of this system can be amortized in eight years, and her electric pump's lifetime will be at least doubled.

A windmill discussion is not complete without a thorough economic analysis. We will look at the cost effectiveness of Samuel's and Barbara's systems in Chapter 6, after the Sailwing discussion.

In concluding this chapter, it is worth repeating that every site and application poses entirely different criteria for the prospective windmiller. Systems should be thought out from beginning to end, and a few years into the future, if possible. Once you begin to purchase your system components, you are on your way. And once you've poured tower footings or drilled your well, there is usually no economical way to turn back. Your best bet is to consult a windmill dealer, or at least a plumber, if he or she is not too skeptical about water-pumping windmills.

If you really feel sure of yourself, and you are willing to get your hands dirty, then read on. The next chapter is for you.

# The Sailwing Windmill

THE NEW ALCHEMY INSTITUTE SAILWING WINDMILL IS A PROVEN MACHINE designed to be built by a “do-it-yourselfer” almost completely from off-the-shelf components (Figure 4.1). The Sailwing is appropriate for agricultural, aquacultural, or domestic use and can be modified to perform a wide range of mechanical tasks. It is capable of the same tasks as conventional water pumpers, but at a reduced cost. It does, however, require more maintenance than commercial mills, and is only appropriate if the operator is willing to climb the tower. For instance, in high winds (greater than 40 mph), the windmill’s sails must be furled to half-mast or the machine will damage itself, whereas commercial machines can stand alone untended in any weather short of a hurricane. The Sailwing owner must either learn to anticipate stormy weather, or be near the machine in case a storm comes up.

Though the Sailwing windmill obviously does not have the eighty-year proven track record of a conventional multibladed water pumper, the machine’s main body should last every bit as long. The sails and minor rotor hardware will need replacement roughly every four to seven years. On the other hand, with the possible exception of the sails, replacement parts are locally available at hardware or auto parts stores. In most cases, sails will need to be ordered from a commercial sailmaker.

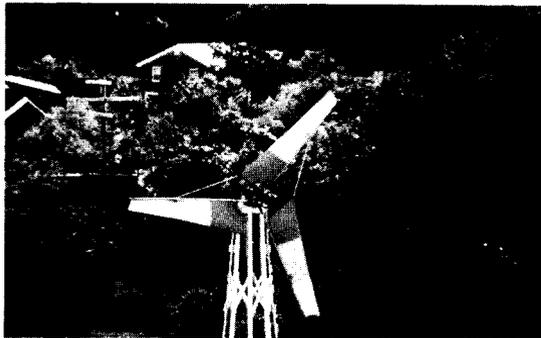

*Figure 4.1. The New Alchemy Sailwing Windmill.*

For the do-it-yourself type, the Sailwing windmill can be the economical windmill solution. A 20-foot diameter Sailwing without the tower will cost in the range of \$875 in materials plus 25 person-hours of construction/labor time. Assuming the Sailwing is on the same tower, with the same pump as a commercial mill, the comparable commercial machine will cost \$3,800 to \$4,500 before shipping.

It is important to say at this point that comparing the Sailwing with a commercial mill is tricky business. While both can perform comparable tasks, their respective ranges of application vary widely. The Sailwing, for instance, features a direct drive (1:1) power transmission from the horizontal rotor shaft to the vertical pump rod. This design eliminates costly gears, the need for an oil-filled crankcase, and a messy annual oil change.

The Sailwing delivers useful pumping power for roughly 30 percent of the capital cost of an equivalent power commercial mill, even when you consider the replacement of sails and minor hardware every four years. Thus, the Sailwing windmill can yield more power for your money, even when life-cycled over twenty years.

Another important factor making comparisons difficult is that the Sailwing windmill's costs will vary with the ingenuity and mechanical aptitude of its owner. Plenty of opportunity exists for cost cutting on parts and construction labor, and no two Sailwings are likely to be built exactly alike. With commercial mills, you are generally limited to the manufacturer's components and have less opportunities for cutting the machine costs.

There are many other obstacles to direct comparisons between the Sailwing and a commercial windmill, but these few should give readers a basic feeling for the differences. Ultimately, the choice of whether to go with a commercial mill or a Sailwing will depend on circumstantial factors including available capital, access to welding equipment and parts stores; and on personal factors such as your willingness to build the mill yourself and to furl sails in anticipation of high winds.

One further point—the Sailwing windmill is a beautiful, breathtaking machine (Figure 4.2). The bright white or multicolored sails are like huge flowers towering over the landscape. It is a

## BACKGROUND

The New Alchemy Sailwing windmill is the scion of a considerable heritage. Cloth-covered wind rotors go back 1,300 years, but are still used today in many countries including Crete, India, Ethiopia, China, and Thailand.

New Alchemy researchers became interested in sailwing windmills in the early 1970s. Their goal was to develop an inexpensive windmill that could be built by do-it-yourselfers in this country as well as in Third World nations—a simple, low-maintenance machine that would be storm-resistant and would also produce useful power in low-wind conditions.

The first New Alchemy Sailwing windmill was built in Southern India in 1973.<sup>10</sup> There, local farmers were experiencing hardship induced by monsoon-related droughts and flooding. Inadequate and costly power sources made reliable irrigation difficult. There was, however, an accessible year-round supply of groundwater. This situation prompted New Alchemist Marcus Sherman to consider harnessing the wind for irrigation on a friend's farm. Because of its simplicity and low construction cost scientists at the Indian Institute of Agricultural Research in New Delhi recommended a modified paternoster pump like that used to drain the mines in Britain in the late sixteenth century. Chain pumps such as this one

10. Marcus Sherman, "A Windmill in India," *The Journal of the New Alchemists* 2(1974):15-17.

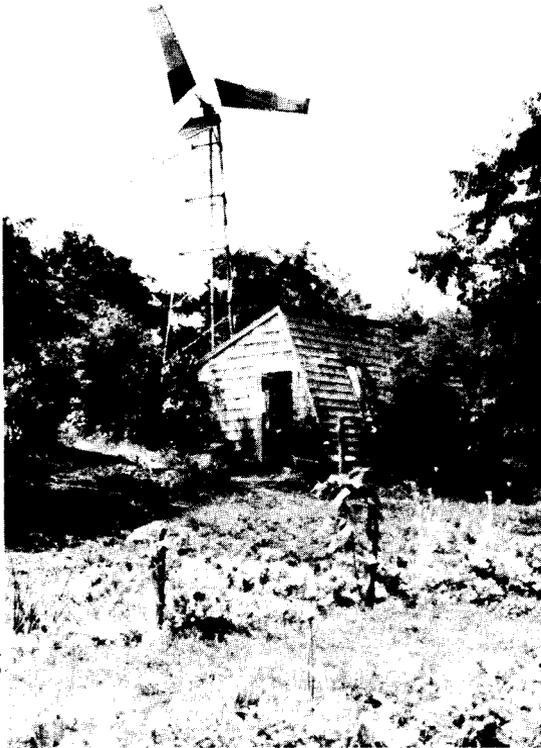

Figure 4.2. A Sailwing at New Alchemy Institute.

joyful, inspiring machine, whose gentle luffing reminds one of ancient travellers and their sail-powered vessels. There is something very right about the Sailwing—it seems a bit more gentle than does its metal-bladed, commercial cousin.

work well with the relatively slow and variable power that is characteristic of windmills.

Marcus developed a mill that was a hybrid of the low-speed 8-bladed Cretan sailwing and the high-speed, aerodynamically efficient Princeton model. To a hub made from a bullock cartwheel roughly 1 meter in diameter, he attached triangular sailing frames made of bamboo. Cloth sails were stretched over the frames to produce stable, lightweight airfoils. The rotor assembly was attached to a used automobile axle. Marcus made a turntable from ball bearings sandwiched between two doughnut-shaped discs. The axle was mounted horizontally on top of the turntable. A rudimentary "squirrel cage" assembly for housing the drive chain and gasket pump was centered on the axle directly above the 1-foot-diameter hole in the turntable.

The Sailwing was headed downwind to prevent the bamboo masts from striking the teak pole tower when bent by monsoon winds. In this way the blades served as their own rudder, trailing in the wind. In the subsequent well digging, the mill was used with a pulley assembly to raise soil and rock from the 20-foot-deep well. Because of its high starting torque at low wind speeds, the mill proved well-suited for year-round irrigation in Southern India.

Back at New Alchemy the following summer, Marcus and Earle Barnhart gave the Sailwing concept another try. First they tried a 6-bladed

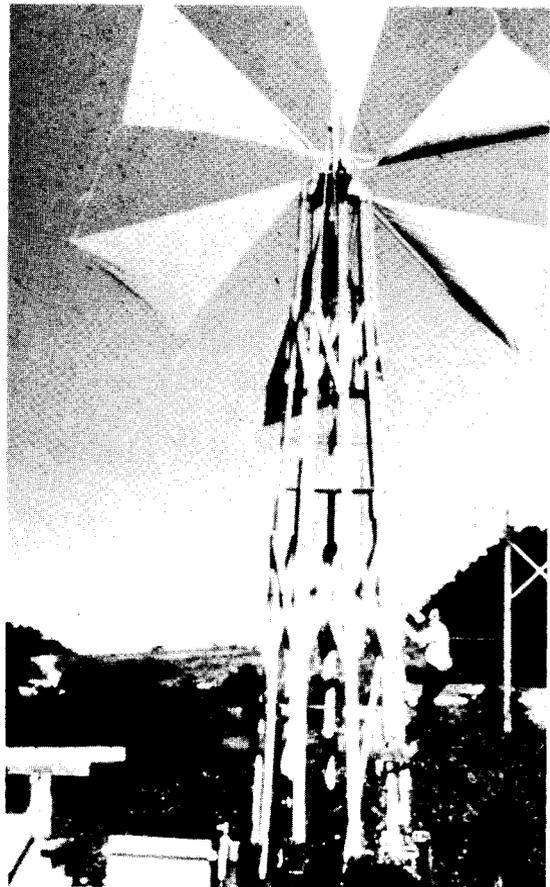

Figure 4.3. *New Alchemy's first Sailwing.*

windmill, like the Cretan machine, but the large rotor surface area became a maintenance headache (Figure 4.3). By summer's end, with lumber





*Figure 4.4. First Big Red Sailing Windmill, 1973.*

and hardware, they built a durable prototype able to withstand the often blustery Cape Cod climate. For a total material cost of \$300, they developed an 18-foot-diameter, cloth sailing capable of pumping 250 gallons per hour in 6-mph winds. Three tapered cloth sails supported by tubular

steel masts extended from a triangular plywood hub. A moveable boom was secured at the root of each sail by a leather strap to encourage self-feathering. Long screen door springs connected each of the 3 sail booms. In early tests, the feathering mechanism withstood a force-nine gale.

A used automobile crankshaft formed the hub and crank. The assembly turned on a ball-bearing turntable which allowed the windmill to seek a downwind operating position. One connecting rod on the crankshaft transferred power to a piston pump below. The entire structure was mounted on a firmly braced 8-legged wooden tower (Figure 4.4).

Over the next six years, Institute researchers tested and evaluated seven Sailing windmills, each with rotor, transmission, or tower modifications.<sup>11</sup> As with any R & D effort, each prototype led to another advance.

The Sailing windmill system that has received more design attention than any of our other experimental mills is known by most friends of the Institute as "Big Red." This machine, so-called because of its bright red Dacron® sails, has been employed at our Cape Cod center to run a variety of aquaculture systems. This particular windmill and pump system has evolved primarily as a high-volume, low-lift WPWS. It is appropriate for many irrigation or aquaculture applications.

11. G. Hirshberg et al., "Wind and Solar at New Alchemy," *Wind Power Digest* 11(1977-78):16-25.

We have employed Big Red for several years to circulate water through an experimental aquaculture facility. The "Miniature Ark" consists of a small closed-loop "river" which courses through three ponds. The bottom pond is solar heated under a greenhouse cover. Here, aquatic microorganisms are cultured as fish feeds in the warm, nutrient-rich waters. The windmill pumps the fish-feed-laden water to the upper ponds where dense populations of fishes grow. The water then flows by gravity back to the lower pond. The Miniature Ark was designed to test the effectiveness of flow or rapid nutrient exchange and bio-purification in a small, backyard-scale aquaculture facility.<sup>12</sup>

In this system, the Big Red windmill and pump have averaged 1,200 gallons per hour in a 12-mph average wind. The pump and pump rod for this job are unique and demand a brief explanation.

The pump is a simple diaphragm device fashioned from a boat trailer tire (See Figure 4.5). Its maximum displacement is 1 gallon. It operates simply by sucking in water past a one-way check valve on the windmill's upstroke, and squeezing water out past a second check valve on the downstroke (See Figure 4.6).

Because of the pump's large surface area, and

12. Ron Zweig, "Three Experiments with Semi-Closed Fish Culture Systems," *The Journal of the New Alchemists* 4(1977):69-77.

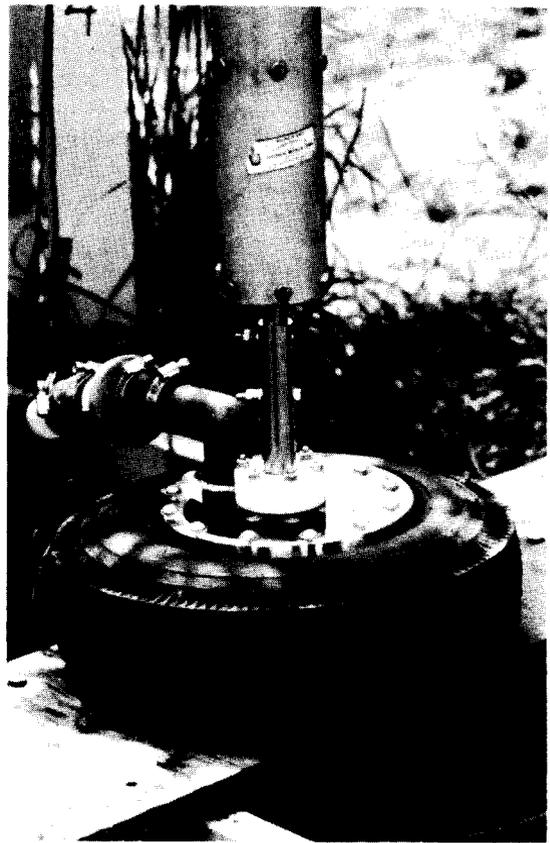

Hilde Mangay

Figure 4.5. *The New Alchemy diaphragm tire pump.*

because it is operating in a slow-speed suction application, the windmill must compress the pump rod with great force (almost 2,000 pounds in a 15-mph wind) to deliver a large volume of water in a short time. These forces would buckle most

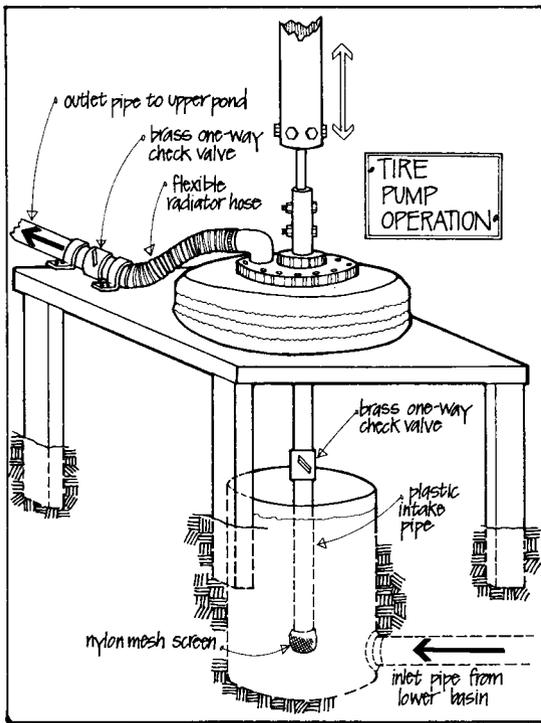

Figure 4.6. The tire pump operation.

pump rod materials, but we have evolved a simple, low-cost, durable solution using 3-inch Electrical Metallic Tubing (EMT®). The Sailwing tire pump system is described in detail, beginning on page 86.

While Big Red is an elegant solution for high-volume, low-lift applications, most jobs require a

system that can raise water hundreds of feet and sometimes thousands of feet in elevation. This task requires a substantially different pump and pump rod arrangement. In 1978, Tyrone Cashman, former New Alchemist and past president of the American Wind Energy Association (AWEA) developed a Sailwing windmill for a high-head application in Northern California.<sup>13</sup> The Green Gulch windmill was used to lift water from a shallow (10-foot) water table to a reservoir 80 feet above on a hillside (See Figure 4.7). The windmill was more sophisticated than earlier mills in a number of ways, and it employed a unique, double-acting pump designed by Peter Fraenkel in Ethiopia (See Figure 2.16, Chapter 2). Tyrone also developed a low-cost, durable, 30-foot wooden tower shaped somewhat like a Coca-Cola bottle. Designed to use lightweight materials (pine 2 x 4s) for ease of construction, he achieved tower strength by spreading weight and pressure over 8 legs. The tower's foundation was made of eight recycled redwood railroad ties, painted with creosote and buried 3 to 4 feet in the clay soil. Circular plywood platforms, dividing the tower into thirds, gave added strength (and convenient work areas). Rigidity was obtained by cross-bracing with 1 x 3s on the lower tiers, and by doubling the 2 x 4 legs at the top. The tower is ideal for dry

13. T. Cashman, "The Green Gulch Sailwing," *The Journal of The New Alchemists* 5(1979):37-43.

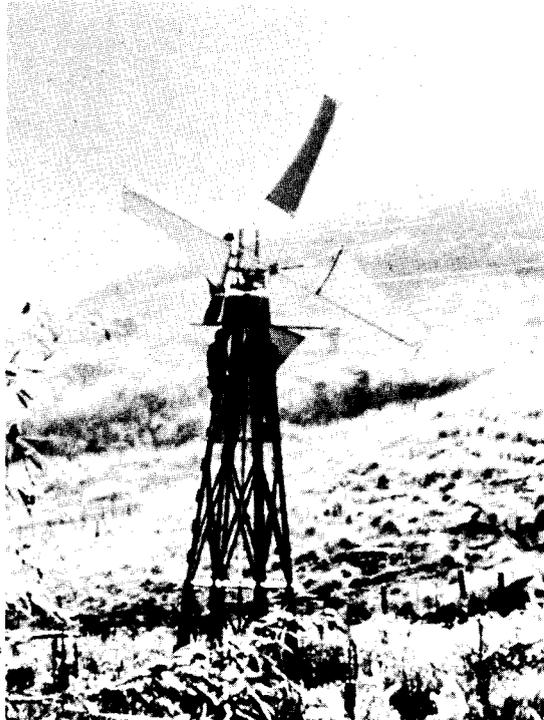

*Figure 4.7. The Green Gulch Sailwing Windmill.*

climates where deterioration is slow, but is not recommended for humid, freezing, or salt air situations.

The Green Gulch mill attempted to circumvent difficulties with earlier crankshafts, and to avoid the cost of the large diameter turntable bearing which permits the side-to-side motion of



*Figure 4.8. A Sailwing windmill irrigating an urban garden in Boston, Mass.*

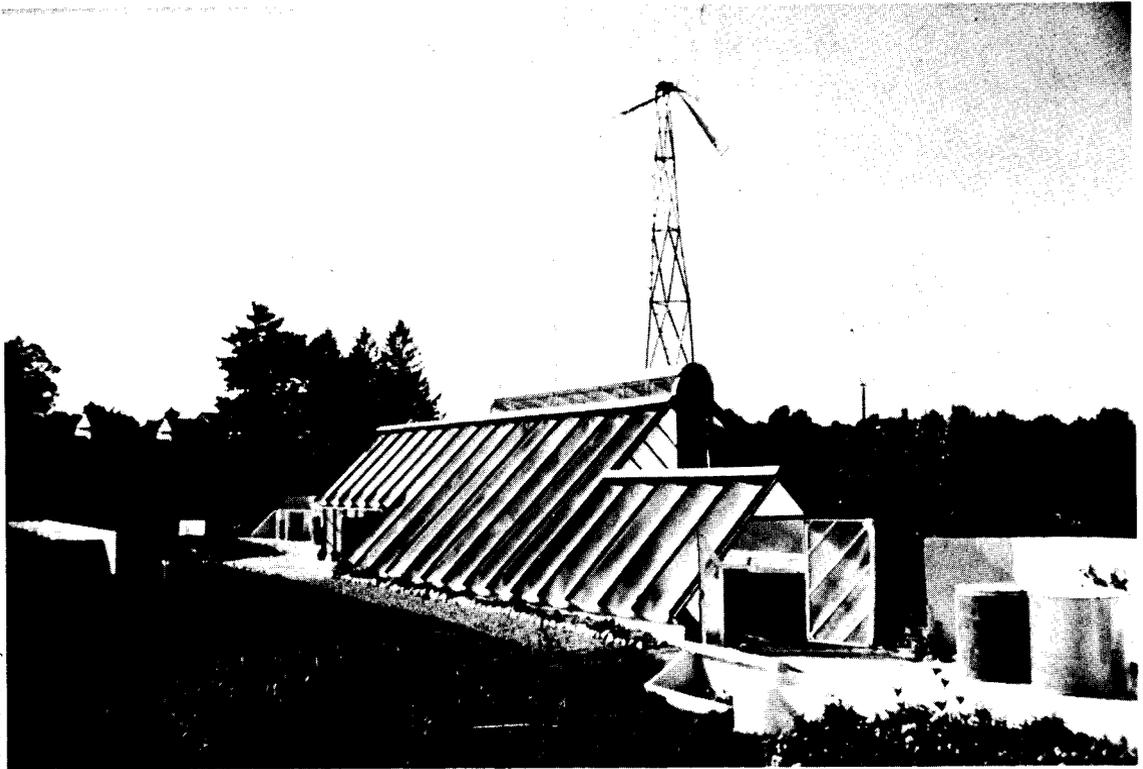

*Figure 4.9. Sailing windmill at the Cape Cod Ark, New Alchemy Institute.*

the direct drive transmission. A vertical connecting rod was installed above the crank rotor disc as a substitute for the direct rod-end design. The connecting rod attached to the vertical pump shaft at a junction box above. The junction box was made to slide vertically up and down in a set

of four castor tracks. The problem with this design was the large number of moving parts that were exposed to climatic deterioration. This transmission, too, required constant parts replacement and costly maintenance.

In 1979, the first U.S. Department of Energy

(DOE) Appropriate Technology Small Grants program awarded New Alchemy Institute a one-year grant to advance the Sailwing design from a prototype to a mass reproduceable product. The goal of the project was three-fold: (a) to simplify the transmission and other components so that the windmill could be made completely from off-the-shelf parts, (b) to build a demonstration prototype in a visible, urban location (Figure 4.8), and (c) to build the final design at our Cape Cod center (Figure 4.9).

This one-year effort resulted in the substantially improved Sailwing windmill. It is a proven design which meets all of the earlier described criteria; yet there is always room for substantial improvements. Even as this book is being written, Jim Jacobs, a small manufacturer in Virginia, is preparing a modified Sailwing for commercial distribution. Jim Jacobs's machine is described in the last section of this chapter.

### **THE NEW ALCHEMY SAILWING: HOW IT WORKS**

We don't pretend to have the ultimate do-it-yourself windmill, but we know that this design is a good one. The Sailwing is the result of a great many years of breakthroughs and failed attempts. Consider the following description and construction manual a useful guideline. The potential for variation in the design is for me one of the Sailwing's most attractive features. Use our experi-

ence, but by all means, experiment. Good luck!

### **THE ROTOR**

**Purpose:** To convert wind energy into rotating shaft power useful for mechanical work.

**Special Design Criteria:** The rotor must develop high starting torque in low winds. It must be self-regulating in high winds so it does not overspeed and damage itself or the pump. The rotor must be easy to construct and aesthetically pleasing.

The rotor is a simple design, employing three Dacron® sails attached to guyed 10-foot masts (Figure 4.10). The rotor shaft is made from 2-inch heavy-wall conduit (water pipe) and the masts are 10-foot sections of 1-inch conduit. Conduit can be welded whereas EMT® or tubing cannot. Each mast is guyed upwind and downwind. The downwind guys have turnbuckles for "coning" the rotor, thus improving the rotor's yawing response to changes in wind direction.

Sets of four sails can be purchased from North Sails East, 305 Sniffens Lane, Stratford, Connecticut for \$190 each. This company uses a 7.5-ounce Genoa style cloth with a special ultraviolet-resistant coating. North Sails East has the NAI sail pattern on file (See Figure 4.11).

Each sail is connected to the adjacent mast and to the tip of its own mast by a ½-inch shock cord. In low winds (0 to 15 mph), the taut sails catch

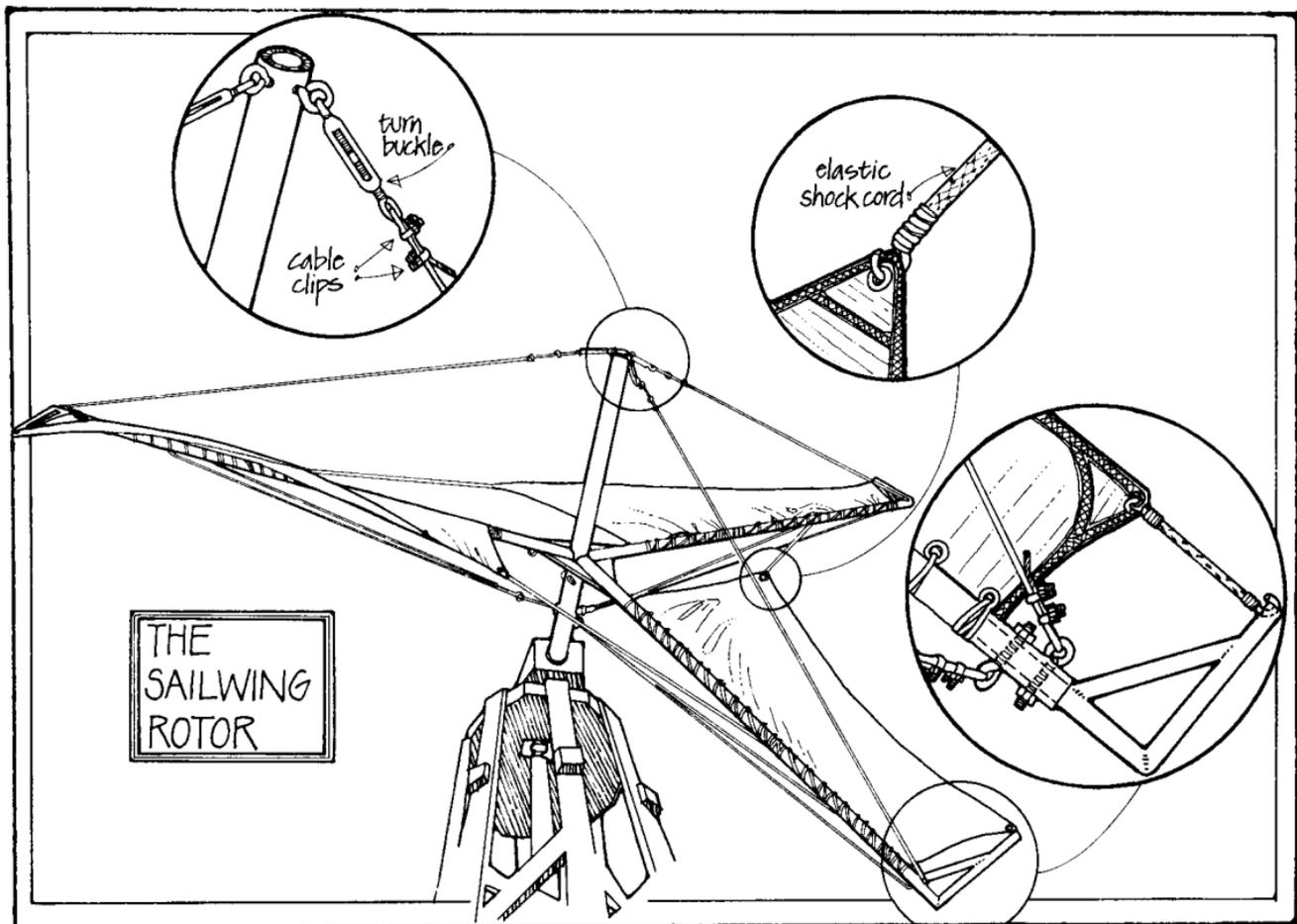

Figure 4.10. The Sailwing rotor.

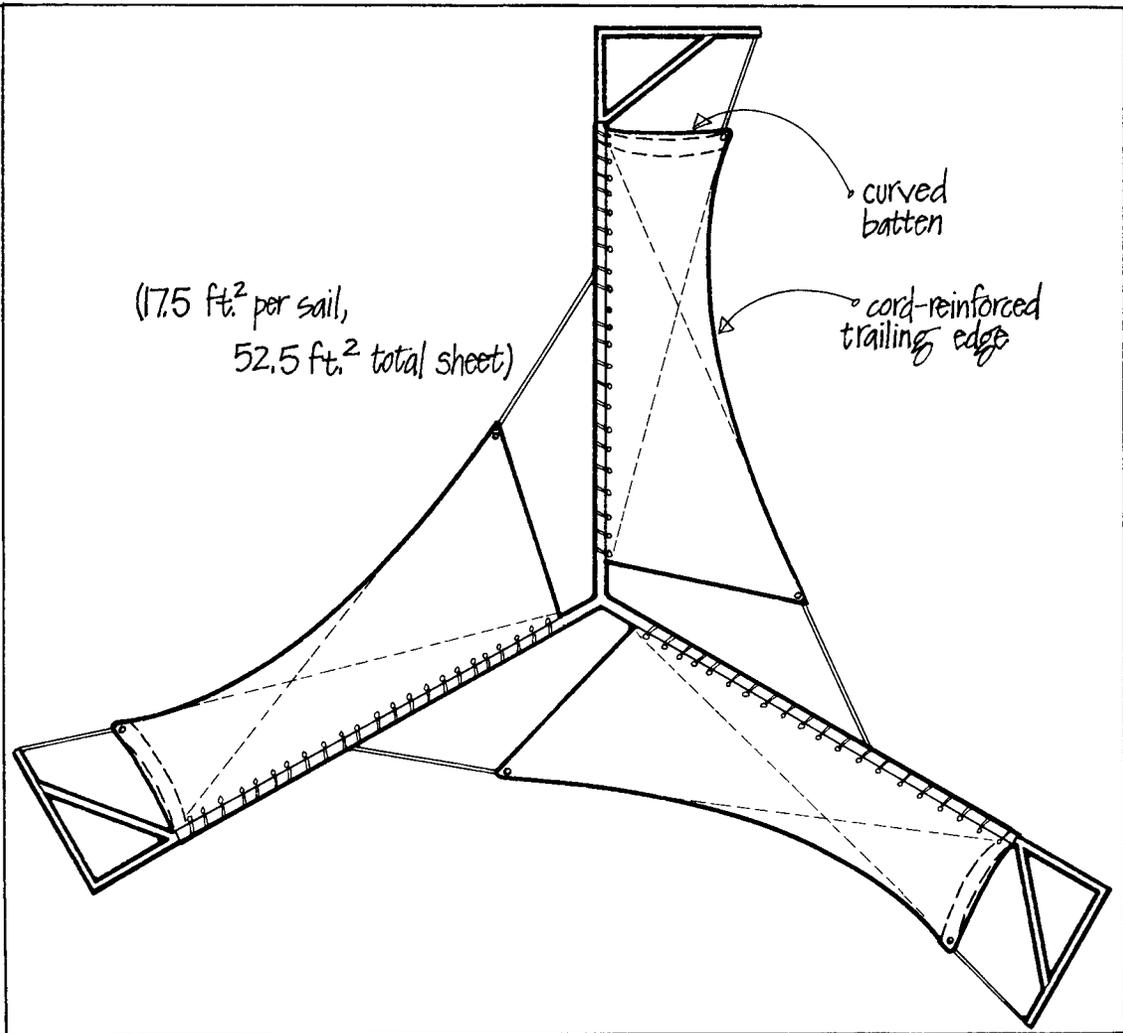
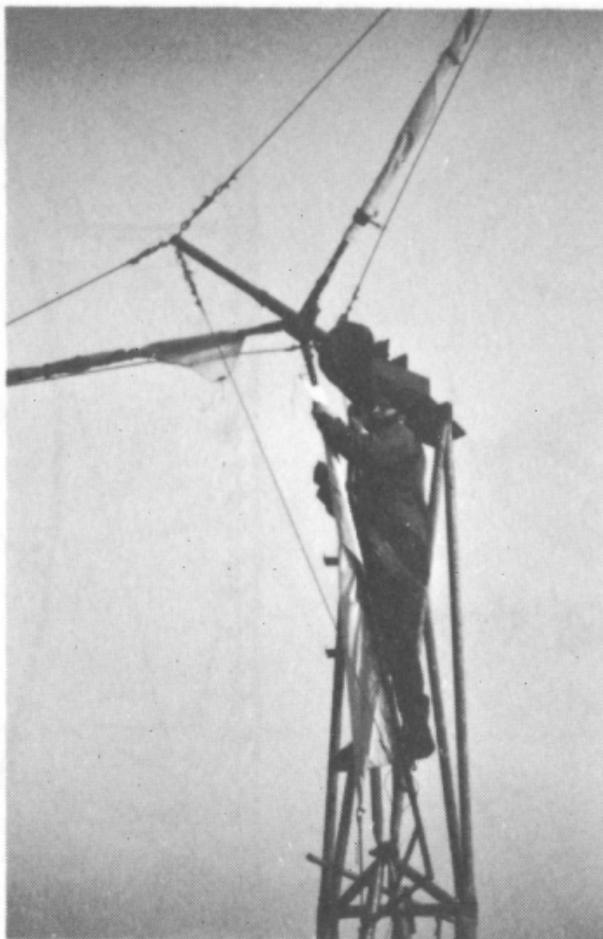

Figure 4.11. The Sailwing sail pattern.



the wind and drive the pump. In higher winds (15 to 40 mph), increased forces on the sails press downwind, stretching the elastic shock cord and allowing some of the wind to spill past the sails. This self-feathering mechanism allows for continuous pumping in higher winds without damage.

In very high winds, the sails must be furled by wrapping the root (the wide hub end) around the mast and securing it with the long shock cord. (Figures 4.12–4.14). The tip remains unfurled and the windmill continues to pump with the sail area decreased.



*Figures 4.12–4.14. Furling the Sailwing rotor.*

Furling in anticipation of high winds is a relatively easy task, but many people are not willing to do this work. Some day I hope to see a roller reefing device as is common on sailboats. This feature would enable safer and simple adjustments from the ground, and encourage wider Sailwing use.

The Sailwing rotor is designed to function downwind from the tower without a tail or rudder. This arrangement saves weight and expense, since a tail capable of keeping a 20-foot-diameter rotor facing the wind must be very long and large. In addition, upwind sails that are able to stretch back away from the wind during gusts are in danger of rubbing against the tower and

catching or even snagging on it when winds are strong. If the rotor is downwind from the tower, the stronger the wind, the further from the tower the sails stretch.

To give good performance in light winds, the Sailwing rotor is made larger than that of the typical American multiblade mill. Extending the masts from 7 to 10 feet adds very little to the cost of a Sailwing rotor. And since the area of a disc varies as the square of radius ( $A = \pi r^2$ ), the wind energy available to a 20-foot rotor is double that for a 14-foot rotor. The extra leverage of the longer rotor arm makes for greater torque and reduced rotation speed, which eliminates the need

for a 4 to 1 reduction gear. The expense, complexity, and weight of a gearbox is thus eliminated.

### THE CRANKSHAFT

**Purpose:** To convert horizontal rotary motion into the vertical reciprocating action of the pump rod.

**Special Design Criteria:** Durability in a high-stress application, and convenient attachments to rotor, turntable, and pump shaft are critical.

The Sailwing crankshaft (Figure 4.15) is built to last and thus incorporates industrial quality bearings and other components. The 2-inch Inside Diameter (ID) rotor shaft slides over a  $1 \frac{13}{16}$ -inch cold-rolled steel shaft which is press-fit into

the two main flange bearings. The crank offset, fashioned from  $\frac{1}{2}$ -inch-thick flat stock gives a fixed  $3\frac{1}{2}$ -inch-radius for a 7-inch stroke. A smaller (1-inch) cold-rolled steel shaft is pressed into this offset and two flange bearings are used to hang the vertical pump shaft.

### THE TURNTABLE

**Purpose:** To support the rotor and crankshaft while allowing horizontal rotation (yaw) in response to changes in wind direction.

**Special Design Criteria:** The turntable must be sturdy, durable, and weather resistant. It must be easily adaptable to different types of tower tops.

Figure 4.16 shows the turntable and transmission mount. The U-shaped shoulder allows for the

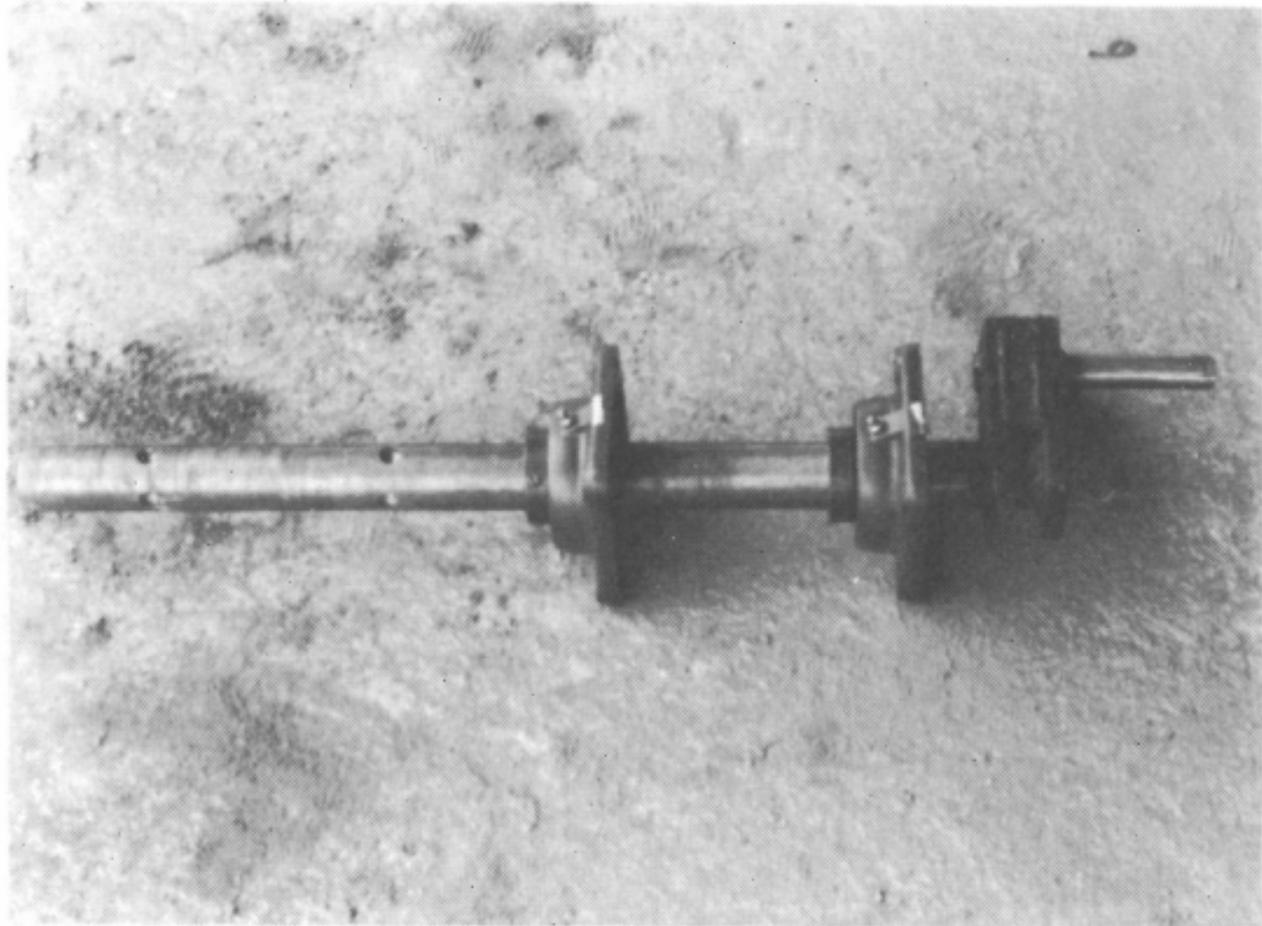

*Figure 4.15. The Sailwing crankshaft.*

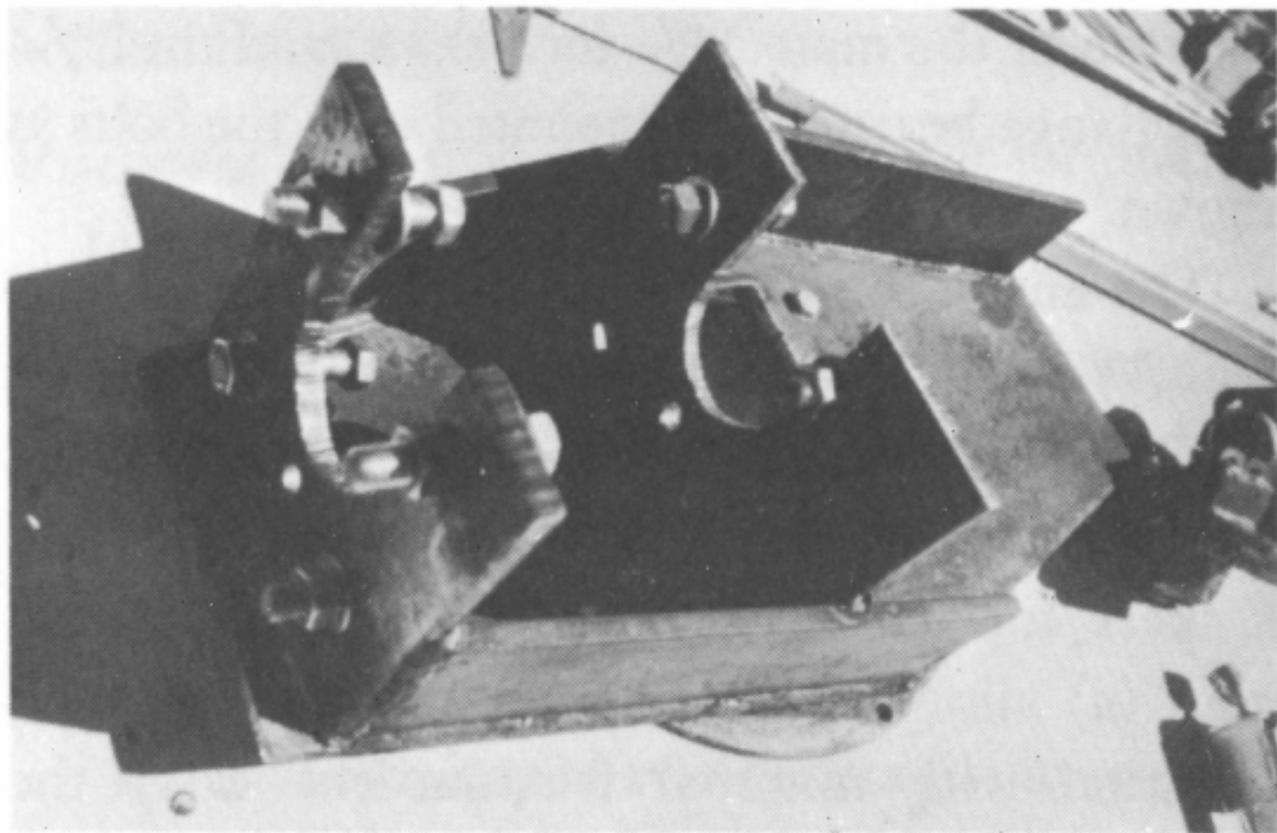

*Figure 4.16. The Sailwing hub assembly and crankshaft mount.*

rotation of the main 1 1/16-inch shaft, and the 1 1/16-inch flange bearings are mounted with the bolts as shown.

The entire turntable assembly is mounted atop a heavy-duty, "lazy susan-type" ball bearing (See Figure 4.17). The "Rotek®" bearing is the single most expensive component in the mill (\$256) but is ideal for its required functions. The bearing must (a) allow yaw in response to changing wind direction with minimal friction, (b) carry the direct weight ( $\pm 100$  pounds) of the hub and rotor, plus the water-lifting force of the sucker rod, (c) accept the very powerful lateral forces on the rotor, (d) allow for the 7-inch side-to-side stroke displacement of the pump rod, (e) conveniently attach to the tower top, and (f) resist being lifted off the tower. The Rotek bearing does all of these. Mounting holes can be drilled in the bearing's

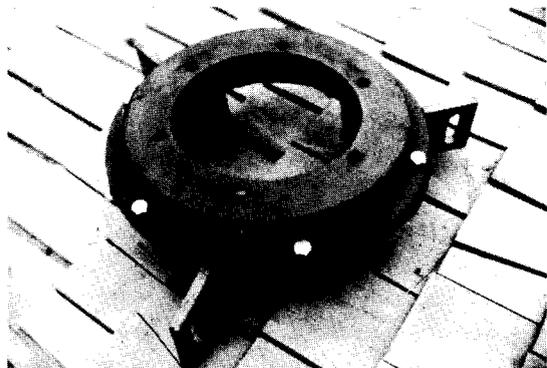

Figure 4.17. The Rotek® ball bearing.

housing to fit any type of tower, providing the tower top has a minimum 16-inch by 16-inch surface area.

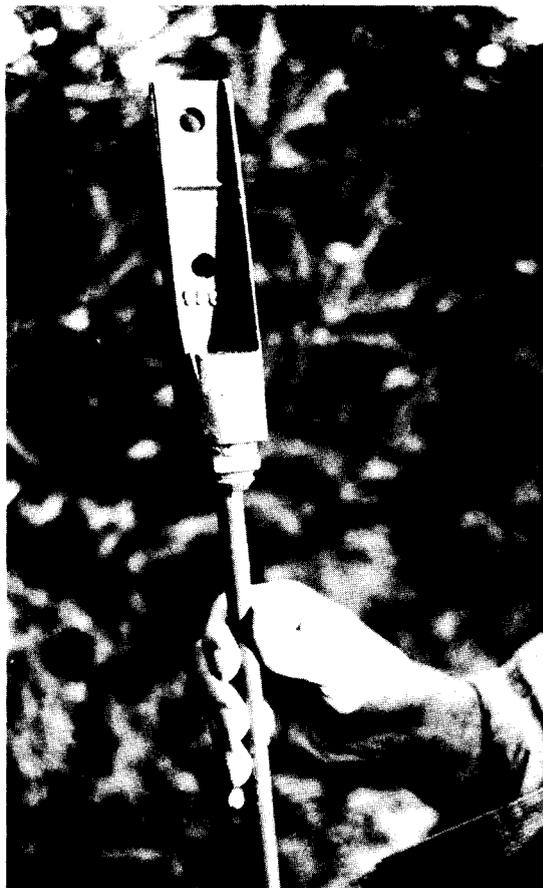
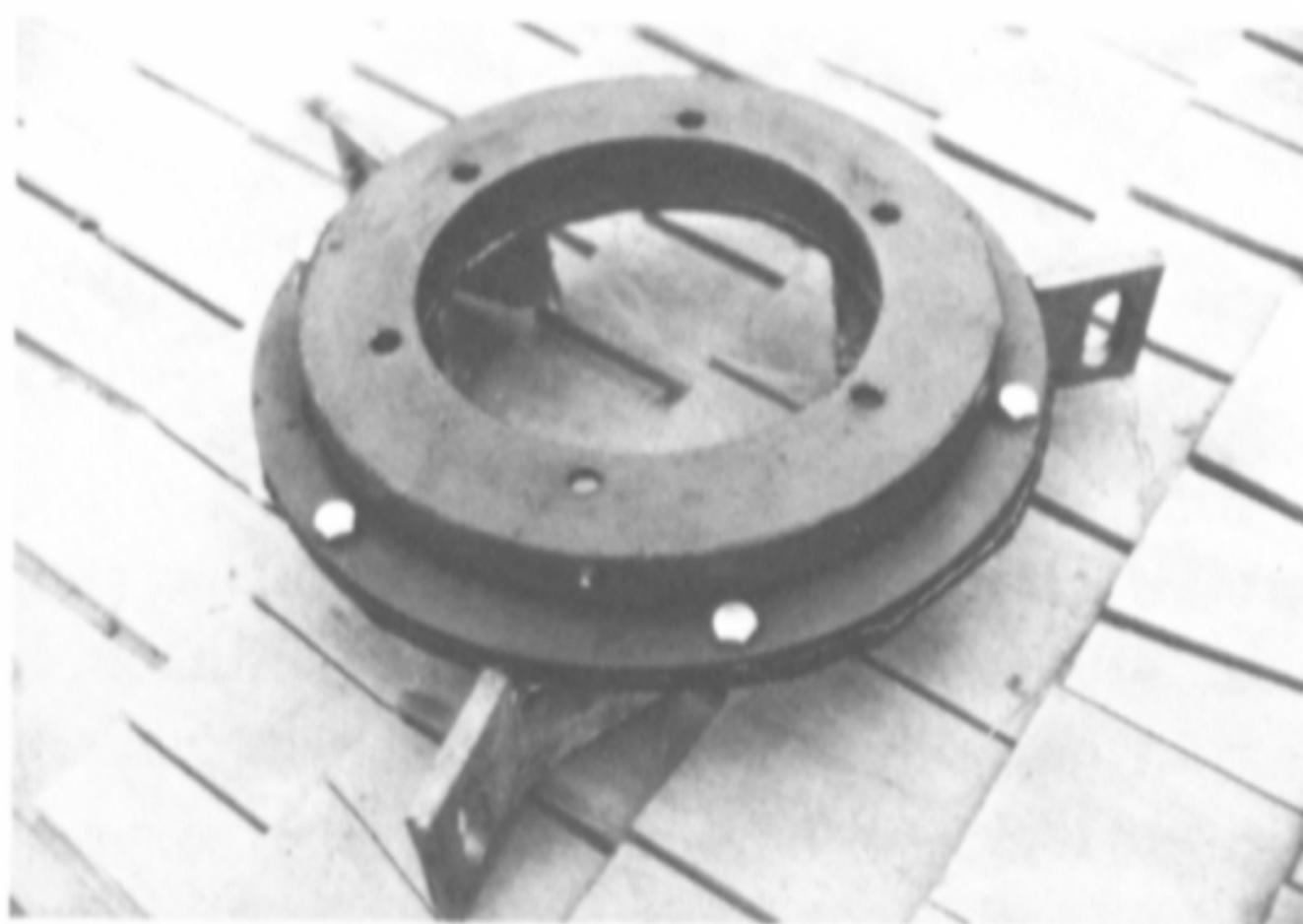
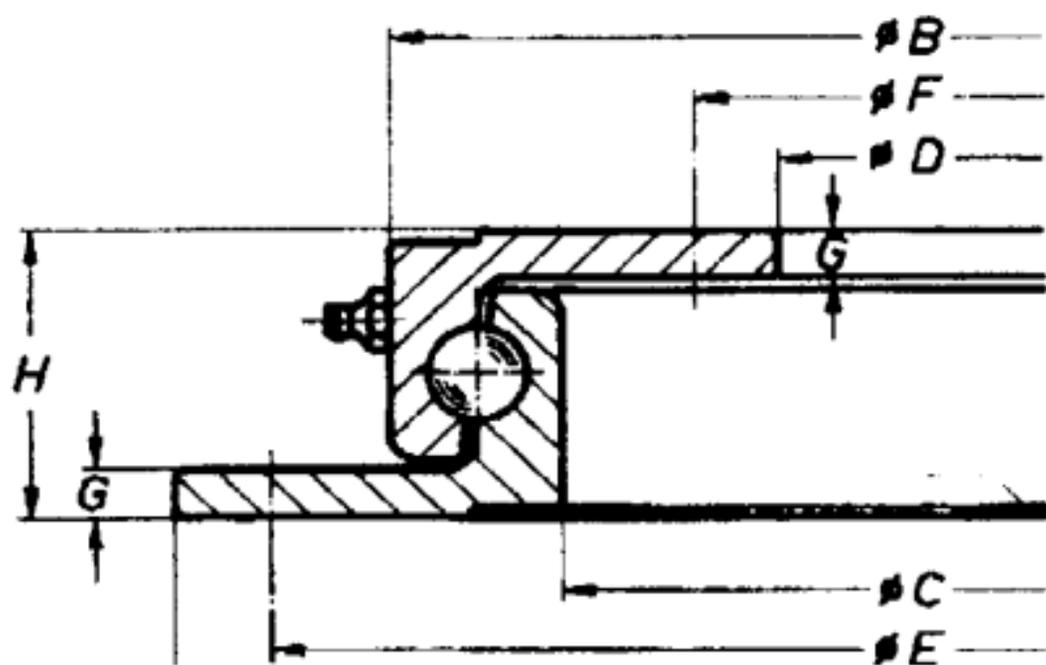

Figure 4.18. The pump rod swivel.



*Figure 4.17. The Rotek<sup>®</sup> ball bearing.*





Der Kugeldrehkranz KLK 400 L  
hat folgende Abmessungen

$\varnothing A =$	400 mm
$\varnothing B =$	342 mm
$\varnothing C =$	292 mm
$\varnothing D =$	230 mm
$\varnothing E =$	375 mm
$\varnothing F =$	260 mm
$G =$	8 mm
$H =$	45 mm
Gewicht =	11 kg
Zul. Axiallast=	7,5 kN



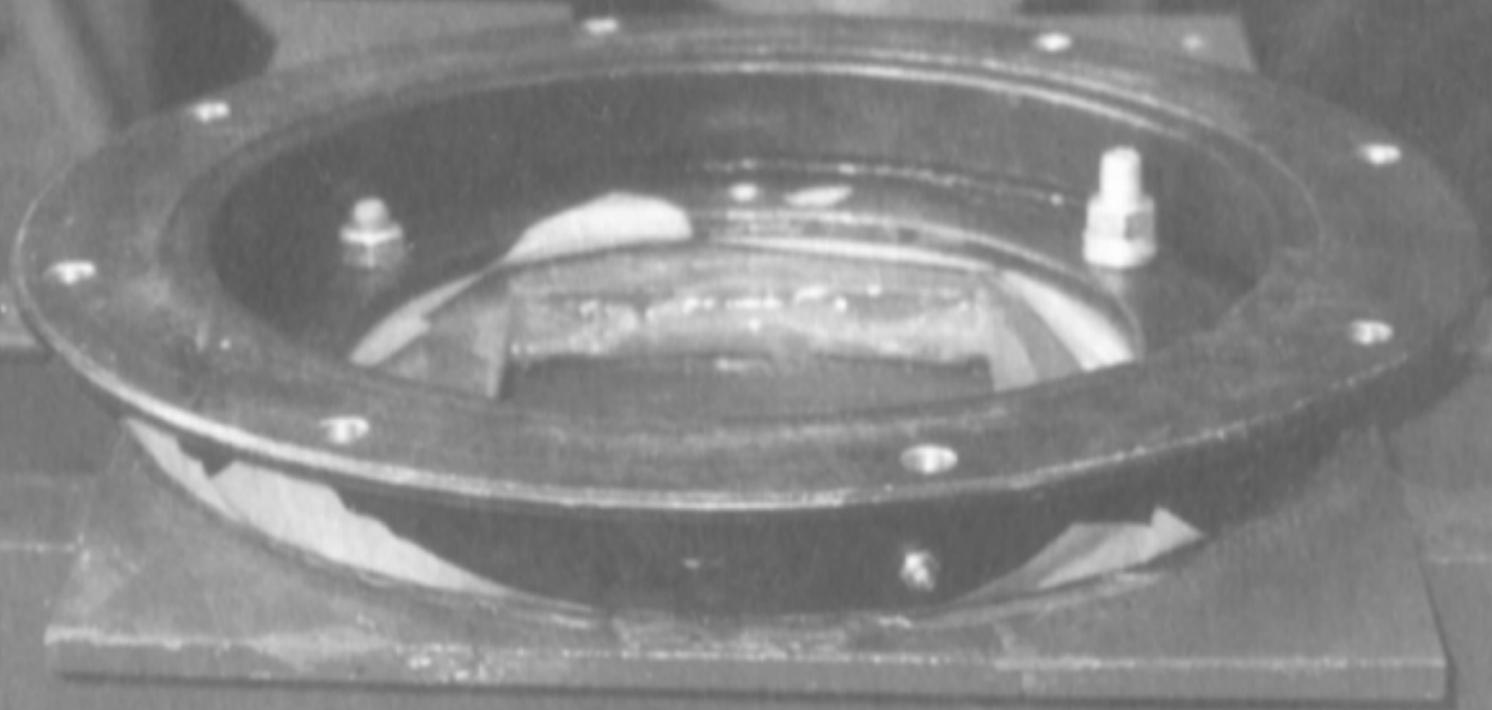

## THE PUMP SHAFT

**Purpose:** To transfer vertical reciprocating motion for the pushing (well-bottom pump) or pulling (suction from above) of water.

**Special Design Criteria:** The components are, for the most part, similar to those of a commercial mill. For instance, a wooden red rod "fuse" is useful to avoid damage to more expensive parts. The Sailwing pump shaft differs in that the swivel must tolerate the side-to-side motion of the pump rod.

We use 1-inch conduit for the pump shaft and simply thread together the appropriate number of sections to accommodate the tower height. Where convenient, we use a 1½-inch by 1½-inch (or 2-inch by 2-inch) red rod with a simple adapter, for security's sake.

At the base of the red rod, we use a commercial windmill swivel casting (about \$29) which affords both simple attachment to the wooden rod and low-friction swivelling capability (See Figure 4.18). The swivel is located at the lower end of the pump rod so that it is not stressed by the side-to-side motion of the direct drive crank offset above. The side-to-side motion is reduced as distance from the crank increases. Locating the swivel below accommodates a braking strategy as well.

## THE BRAKE

**Purpose:** To stop the Sailwing rotor for manual furling or in case of an emergency.

**Special Design Criteria:** The brake lever must be easily accessible. Although braking is rarely required, easy accessibility can be critically important in emergencies.

We have developed two braking strategies for Sailwing builders. Both are effective, and the choice largely depends on financial considerations. We used the simpler and lower cost mechanism on the Boston mill. We'll refer to this mechanism as the turnout lever. A handle is attached to the vertical pump rod, above the pump rod swivel and roughly at the same height as the rotor tip in the lowest part of its revolution. The operator simply takes a position at that point (inside the tower) and by means of the handle turns the machine on its turntable bearing so that the rotor is parallel to the wind. The operator can grab a rotor mast with the free hand as the rotor slows to a stop. Furling proceeds from there, or in the case of repairs the blade is tied off to the tower. The rotor is not tied off until all three sails are furled, or something is likely to be damaged.

The other braking technique employs an automotive emergency brake that can be engaged from the ground. However, releasing the brake still

requires climbing the tower. The advantage of this brake is that the operator can apply it in a high wind without climbing the tower. This brake, which we'll call the rotor brake, is more expensive and complicated to construct than a turnout lever.

A brake drum is attached to the main rotor shaft, and the backplate with the brake shoes is

bolted to the main hub bearing mount (Figure 4.19). It is important that the brake drum be large enough to allow the 2-inch rotor shaft to pass through its center. A simple linkage is built on the backplate, with a cable running over pulleys to the brake lever below. Once the brake is engaged, the operator must climb the tower to reset the lever before the mill can begin turning again. Future machines may feature brakes that can be reset from the ground.

### THE TOWER

**Purpose:** To elevate the Sailing rotor to a height where unobstructed winds are available.

**Special Design Criteria:** Wood is an acceptable material in dry climates where deterioration is slow. Galvanized steel must be used in other climates. The tower top must be no less than 16 inches x 16 inches for mounting the turntable bearing. The tower should flare out gradually from the top down, so that the 11 foot-long windmill masts will not strike the tower when they are pointing straight down.

You can visualize the clearance needed for the masts by imagining a stick that hangs out 26 inches from the tower top in each direction. If you hang an 11-foot rope from the end of the stick, the rope would approximate the position of the rotor masts.

If you are considering a used tower, actually



Figure 4.19. The rotor with brake drum.

carry out this measurement. If you are buying a new tower from a catalog, ask your dealer about mast clearance before you buy!! Actually, the coning of the rotor helps to eliminate the problem but you're better off with a margin of safety.

**THE PUMP ASSEMBLY** (including drop pipe, packer head, pump rod, pump, and strainer)

**Purpose:** To move water by pressure or by suction from one location to another.

**Special Design Criteria:** The Sailwing system requires the same pump assembly design considerations that apply to commercial mills. All of the components are the same.

In selecting the proper pump size, as with a commercial windmill, you will need to know (a) the height you must pump water, (b) the desired pumping rate, and (c) the distance you must move water (for computing pipe friction).

## HOW TO BUILD THE SAILWING WINDMILL

The following plans are designed to serve as a construction guide or shop manual. If you are not quite ready to build, turn ahead to the section titled Jim Jacobs's Sailwing.

### THE ROTOR *Parts List*

(1) 1<sup>1</sup>/<sub>16</sub>-inch x 30-inch cold-rolled steelshaft

- (1) 5-foot piece of 2-inch rigid electrical conduit or water pipe (black pipe is OK)
- (3) 15-inch pieces of 1<sup>1</sup>/<sub>4</sub>-inch rigid electrical conduit or water pipe
- (3) 10-foot pieces of 1-inch rigid electrical conduit or water pipe
- (3) 18-inch pieces of <sup>3</sup>/<sub>4</sub>-inch rigid electrical conduit or water pipe
- (3) 26-inch pieces of <sup>3</sup>/<sub>4</sub>-inch rigid electrical conduit or water pipe
- (3) 14-inch pieces of <sup>3</sup>/<sub>4</sub>-inch rigid electrical conduit or water pipe
- (1) equilateral triangle of <sup>1</sup>/<sub>2</sub>-inch hot-rolled steel (9-inch x 9-inch x 9-inch )
- (70) feet of <sup>7</sup>/<sub>32</sub>-inch or <sup>3</sup>/<sub>16</sub>-inch, 7 x 19 galvanized wire rope. If you can afford it, stainless steel, available at aircraft and marine hardware stores, is better.
- (24) <sup>1</sup>/<sub>8</sub>-inch cable clamps (drop-forged are more durable than malleable but cost twice as much)
- (3) timbles for the cable
- (9) <sup>3</sup>/<sub>8</sub>-inch x 3<sup>1</sup>/<sub>2</sub>-inch galvanized eyebolts with nuts and lockwashers
- (3) <sup>3</sup>/<sub>8</sub>-inch turnbuckles, iron or steel only, preferably forged
- (6) <sup>1</sup>/<sub>16</sub>-inch NC x 3<sup>1</sup>/<sub>2</sub>-inch hardened bolts with nuts and lockwashers

- (6) ⅝-inch NC x ¾-inch hardened bolts with nuts and lockwashers

**Note:** Hardened bolts can be obtained at larger hardware stores, industrial supply stores, and some auto supply stores. They are sometimes called "high strength" bolts. There is usually an identifying mark on the bolt head consisting of three lines pointing toward the center of the head. Ordinary hardware store bolts will not do!

- (3) 1-foot pieces of ½-inch heavy duty shock cord  
(3) 3-foot pieces of ½-inch heavy duty shock cord  
(3) sails (see pattern, Figure 4.3)  
(1) ball of nylon twine  
(1) roll of duct tape  
(1) pint of galvanizing paint  
(1) tube of "LocTite®" or other bolt-locking compound

If using a rotor brake:

- (1) rear-wheel brake drum, backing plate, and emergency brake mechanism from Plymouth Duster, Valiant, Dodge Dart, or any other vehicle having a brake drum with at least a 2-inch diameter hole through the center. You'll also need an assortment of heavy scrap steel for the various parts, levers, pulleys and cable, and so forth, depending on the brake drum chosen.

### *Procedure*

If using the rotor brake, begin with Step 1. If using the turn-out lever, begin with Step 2, and ignore references to the rotor brake.

**Note:** The drilling of large holes is best done by a machine shop, as it is important that they be accurate.

When welding galvanized metal, the galvanized coating should be filed or ground off the area to be welded, and the welded area protected afterwards with zinc paint.

**CAUTION:** Welding galvanized conduit generates deadly fumes. Weld outdoors. Do not stand downwind. Do not breathe fumes at all. If headache begins, stop work and seek clean air immediately!

1. Drill a 2⅛-inch hole exactly in the center of the brake drum. Insert the 2-inch conduit into the drum from the outside so that the end of the conduit extends ½-inch beyond the inner face of the drum. (This gives you something to weld to.) Weld the brake drum to the end of the conduit, making absolutely sure that the drum is both square and centered. This alignment is very important for the proper working of the brake! Take your time. Start by making three "tack welds" 120° apart, checking alignment after each tack. Then weld both sides of the drum to the conduit. Re-check the alignment several times as

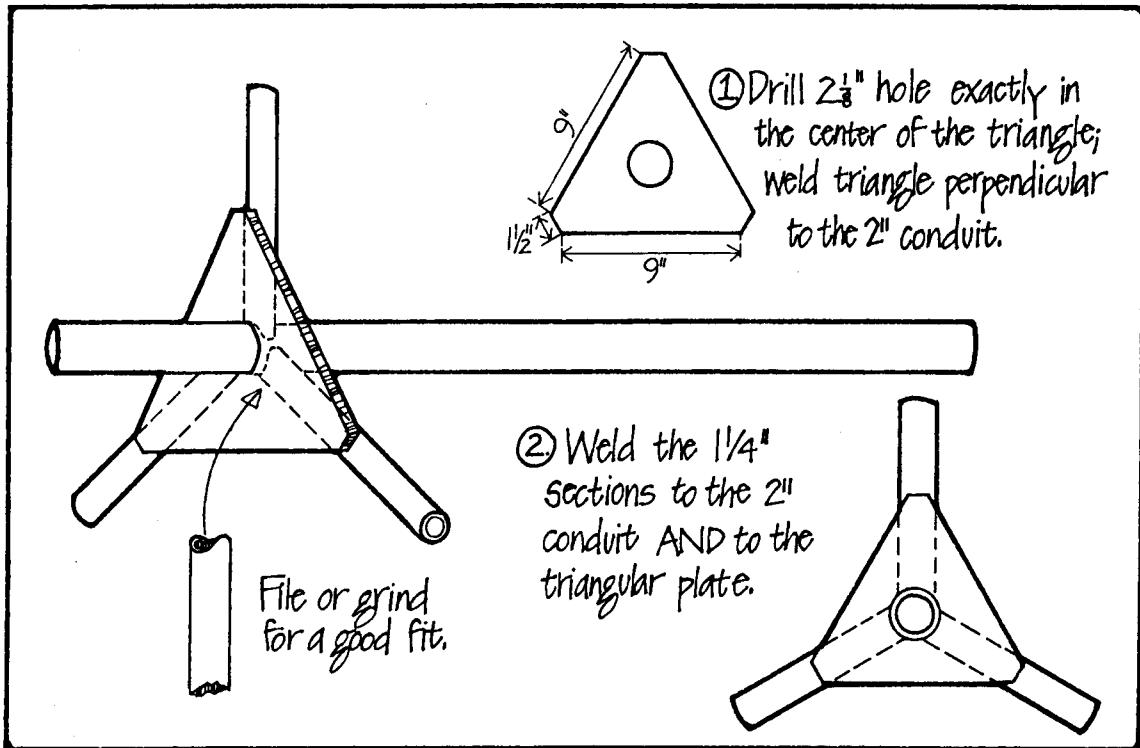

Figure 4.20. The Sailing rotor hub.

welding progresses. Avoid overheating the assembly, as this will warp it.

2. Cut the corners of the steel triangular plate so that they form a  $\frac{1}{2}$ -inch-wide edge (See Figure 4.20). Drill a  $2\frac{1}{8}$ -inch diameter hole in the exact center of the triangular steel plate. Weld the triangular plate to the 2-inch conduit at a

point  $10\frac{1}{2}$  inches from the brake drum or, if not using the drum,  $10\frac{1}{2}$  inches from the end of the conduit. Take extreme precautions that this plate is perpendicular to the conduit. Misalignment here will lead to long-term grief! The best way to insure proper alignment is to make three tack welds  $120^\circ$  apart, recheck the alignment, and



then complete the weld on both sides of the plate. Do not overheat and distort the work. Check the alignment often as you weld.

3. Weld the three 15-inch pieces of 1¼-inch conduit to the 2-inch conduit and to the triangular plate. Grind or file off the galvanizing where the welding will be done. File or grind a concave section in one end of each piece so that it fits snugly on the 2-inch conduit (See Figure 4.20). Align the short pieces so that they will be 120° apart and the points of the triangle fall exactly on their centerlines. **It is critical that the short sections of conduit stand perpendicular to the 2-inch conduit, and at the same time are flat against the triangular plate on the nose (long) side of the 2-inch conduit.** Because of the long rotor masts, a small error here will result in severe rotor wobble and/or unbalance that will quickly damage the machine and waste your work! First weld the short sections to the 2-inch conduit, then clamp them to the plate. When welding them to the plate, it will probably be necessary to use very high amperage and a small (⅛-inch) rod to get good penetration.

4. Measure 3 inches and 10 inches from the triangular plate toward the brake drum end of the 2-inch conduit (the short end). At each of these locations, drill three ⅜-inch holes, spaced 120° apart around the conduit. Slide the 1'⅞-inch steel shaft into the conduit from the short (brake drum) end until it reaches the triangular plate.

Drill through the ⅜-inch holes you have already made in the conduit until you have made shallow holes ½ inch deep in the shaft. Do not let the shaft rotate in the conduit while you are drilling the holes. Punch-mark the shaft and conduit to make reassembly easy later. Remove the shaft. Tack weld ⅜-inch hardened nuts over the holes in the conduit. The bolts through these nuts into the shallow holes in the shaft will lock the conduit hub assembly to the shaft (See Figure 4.21). Make up three right-angle pieces with ⅜-inch holes in each leg as shown in Figure 4.21. Insert a cable thimble in one hole, and use the other hole to bolt the brackets to the hub as shown in the figure. The brackets will receive the upwind mast guy cables.

5. Make up three right triangles from the ¼-inch conduit. The legs should be 26 inches x 18 inches and the hypotenuse 14 inches. The hypotenuse forms a small inner right triangle with approximately 10½-inch sides. Grind off the galvanizing to insure a good weld (See Figure 4.22 and Figure 4.10). Drill a ¼-inch hole in the end of the short triangular tip.

6. Insert the long end of each triangle into one end of each 10-inch piece of 1-inch conduit. As you straddle the 1-inch conduit looking at the triangle, point the triangle leg to the left. (This will produce counterclockwise rotation; pointing them right will give clockwise rotation. Be sure to change the position of the eyebolts if clockwise

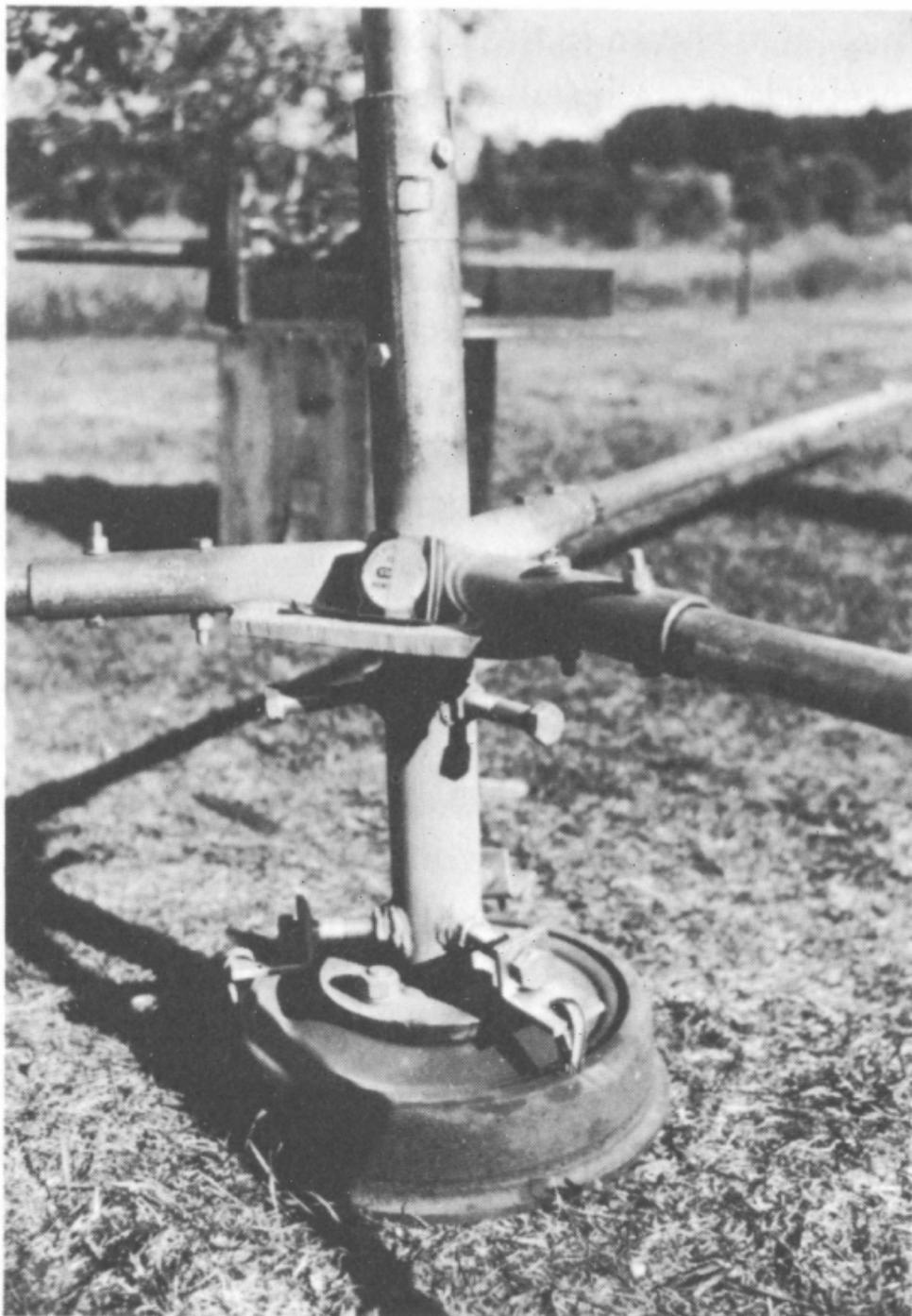

*Figure 4.21. Guy cable attachments on the hub bolts.*



*Figure 4.22. The rotor tip assembly*

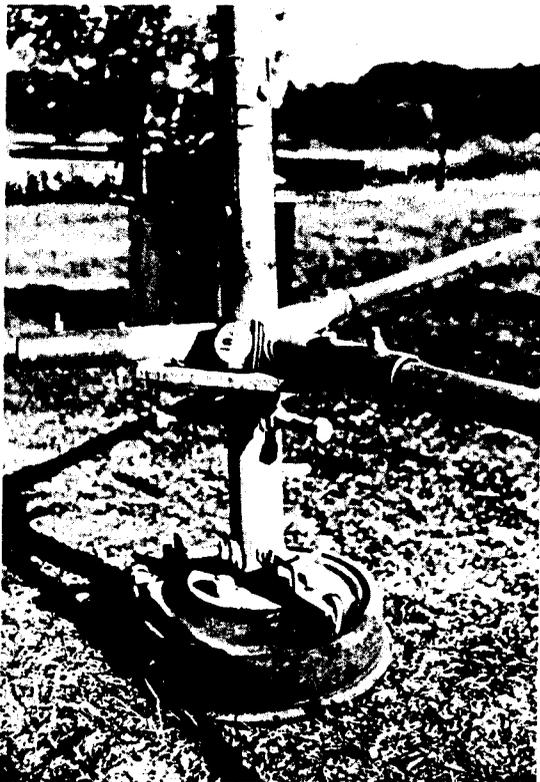

*Figure 4.21. Guy cable attachments on the hub bolts.*

rotation is desired). The triangles can slide into the 1-inch conduit as far as the hypotenuse welds. Use discretion in your choice of length. The longer the total mast, the more powerful your rotor will be. However your tower may not permit excessive length. We usually leave 18 inches

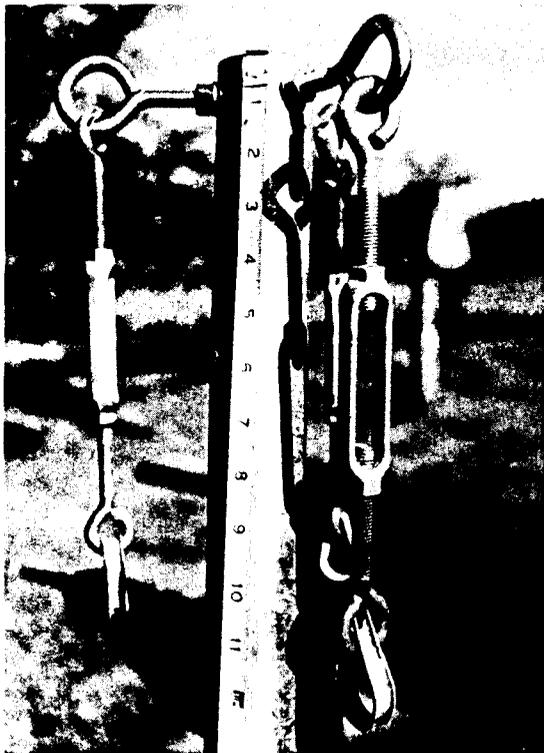

*Figure 4.22. The rotor tip assembly (see also Figure 4.11).*

of the triangle sticking out. Lay each triangle-conduit assembly on a flat surface and drill vertically two  $\frac{1}{16}$ -inch holes side by side 3 inches apart. The first hole should be 1 inch from the end of the conduit tip, and both holes should go right through the conduit and the triangle. A "Port-align" drill guide (Sears) makes this sort of drilling easier. Insert eyebolts, the one nearest the triangle, eye up, and the other one, eye down. Use lock washers under the nuts. Measure 48 inches down from the end of the 1-inch conduit mast (including the inserted triangle section). Drill a  $\frac{3}{8}$ -inch hole horizontally through the mast and insert an eyebolt with the eye on the side of the mast opposite the way the triangle is pointing. (Figure 4.10).

7. Support the 2-inch conduit of the hub assembly vertically with the short (brake drum)

end down. (That is, the short end below the triangular plate). One inch down from the upper end of the 2-inch conduit ("the nose"), drill three  $\frac{1}{16}$ -inch holes  $120^\circ$  apart. Using a nut and lock washer on both sides of the tube wall, install three eyebolts with their splits facing up (See Figure 4.23). Pry open the splits and install the turn-



Robert Sardinsky

*Figure 4.23. The rotor nose eyebolts and guy wire attachments.*

buckles as shown in the photo. Make sure that the turnbuckles are installed so that they all turn the same way to tighten. Squeeze the eyes shut with large Channellocks® or ViceGrips®. Extend the turnbuckles equally as far as possible while maintaining total thread engagement at both ends.

8. Insert the 1-inch conduit masts into the  $1\frac{1}{4}$ -inch short conduit sections of the hub as shown in Figure 4.21. Point the triangles to the right. This will give clockwise rotation, looking at the rotor from upwind. To give the sails a bit of twist for good starting torque, lift the tips of the triangles about  $10^\circ$  from the horizontal. While the tips are supported in that position, go to the hub and drill two  $\frac{1}{16}$ -inch holes 4 inches apart vertically through each  $1\frac{1}{4}$ -inch conduit piece with the mast inserted in it. The first hole should be 1 inch in from the outer end of the  $1\frac{1}{4}$ -inch conduit piece. Make sure all the masts are installed at the same angle. Bolt with the  $\frac{1}{16}$ -inch bolts, nuts, and lockwashers. The last job is to paint the entire rotor assembly with zinc paint. Prime the galvanized parts with "metal etch" acid to insure good adhesion. Avoid painting the friction surface of the brake drum.

9. Rigging the rotor with guy cables is a simple procedure. With the rotor still supported horizontally as before, work first on the end that is down (the upwind end). Cut a length of cable long enough to reach from the thimble on the angle bracket, to the eyebolt that faces down near

the mast's triangular endpiece. Add about 8 inches at each end for clamping. Loop the cable through the thimble and apply two cable clamps about 4 inches apart. The "U" should be over the short end of the cable. The clamp nearest the thimble should be jammed tightly against it. It is easy to manage these clamps if they are held in a Vicegrip® while you tighten them. (The smallest size Vicegrip® or the new longnose type works best). Taking up all the slack, apply two clamps at the eyebolt. The clamp nearest the eye should be as close as possible without kinking the cable. Make each cable's tension as similar as you can, but do not bend the masts.

The nose guys are next. Cut cable of sufficient length to reach from the eye-up eyebolts at the mast tips to the semicircular loops at the nose. Fig. 4.10 shows the turnbuckles at the nose with eyebolts. We have since opted for making the turnbuckles more accessible by placing them at the mast tips. Add 6 inches of cable at the loops and install two clamps in the same way as before. At the mast end, attach a turnbuckle and pull about 15 inches of cable through the eye of the turnbuckle so as to bend the masts up rather like a shallow umbrella. Again, use two clamps. Tighten the turnbuckles to achieve an upward bend of about 12 inches from the horizontal. Lock the turnbuckles by passing a wire from one eye through the center piece and then to the other eye. (Copper wire is best.) Use discretion in bending

the masts! The exact angle is not critical, but they should all be the same.

10. Rigging the sails is the easiest job. They are not rigged until the machine is actually on the tower to avoid tearing them during the erection process (Figure 4.24). Position the sail, wide end near the hub, grommetted edge against the mast. Knot the nylon twine around the second eyebolt

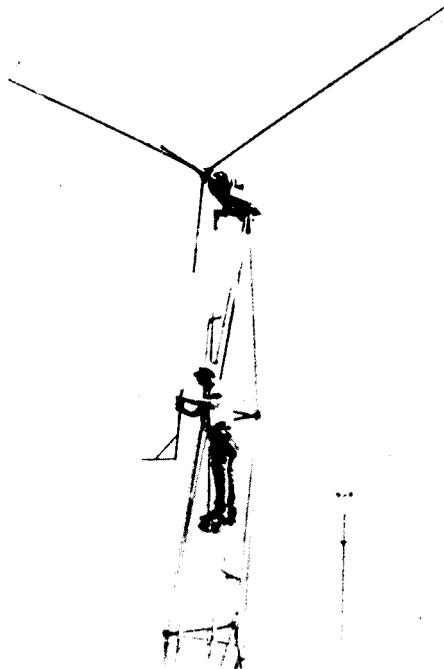

Figure 4.24. Scott Stokoe rigging the sails.

from the end of the mast. (The one that holds the upwind guy). Use a Bowline or double-tied square knot. Pull the twine through the first grommet of the sail, around the mast, and then do it again. Then run the twine to the next grommet, taking the twine under the mast as you go. Keeping the twine tight, repeat this step until you reach the end. Tie the twine around the 1¼-inch conduit between the bolts so as to retain the knot. Connect the short shock cords between the ¼-inch hole in the mast tip triangle and the grommet in the sail corner. The long shock cords run from the sail corner grommet at the hub end, to the eye-bolt halfway up the next mast, as shown in Figure 4.10.

## THE CRANKSHAFT

### *Parts List*

- (2) 1<sup>1</sup>/<sub>16</sub>-inch Fafnir RCJ self-aligning flange bearings (4-hole mounts)
- (8) ½-inch x 2-inch hardened bolts, nuts, lock washers
- (2) 1-inch Fafnir RCJ self-aligning flange bearings (4-hole mounts)
- (8) 7<sup>1</sup>/<sub>16</sub>-inch x 2¼-inch hardened bolts, nuts, lock washers
- (1) 24-inch x 1-inch cold-rolled steel shaft
- (2) 6-inch x 3-inch x ½-inch hot-rolled steel plates (crank plates)

- (2) 1-inch x 3½-inch x ⅜-inch hot-rolled steel plates (crank sides)

### *Procedure*

The critical goal in this process is to ensure that the crankpin (1-inch) shaft is exactly parallel to the main (1<sup>1</sup>/<sub>16</sub>-inch) shaft. If the shafts are not parallel, the bearings will wear unevenly, and costly parts replacement will be necessary in the first year.

1. Drill a 1⅛-inch hole and a 2-inch hole, 3½ inches apart from hole center to hole center in the 6-inch x 3-inch crank plates (see Figure 4.25).

2. Place the 1<sup>1</sup>/<sub>16</sub>-inch shaft in a vice so it is secure. (See Figure 4.26.) Slide the 1<sup>1</sup>/<sub>16</sub>-inch shaft through the larger holes in the crank plates. Slide the two drilled-out plates over the 1-inch shaft. Remove the assembly from the vice and lay everything on the work bench. Lay the crank sides between the crank plates and hold the plates and sides together with a "C" clamp (Figure 4.27).

Ultimately, you will only need 6 inches of the 1-inch shaft. However the full 24-inch length is needed to line up the shafts as shown. Use a piece of scrap steel or wood for a spacer if needed.

Once all the parts are in place and are square, recheck and tack weld. Begin by welding the crank sides to the crank plates. Then tack weld the crank plates to the 1<sup>1</sup>/<sub>16</sub>-inch shaft. Before you weld the crankpin shaft, be certain that the proper

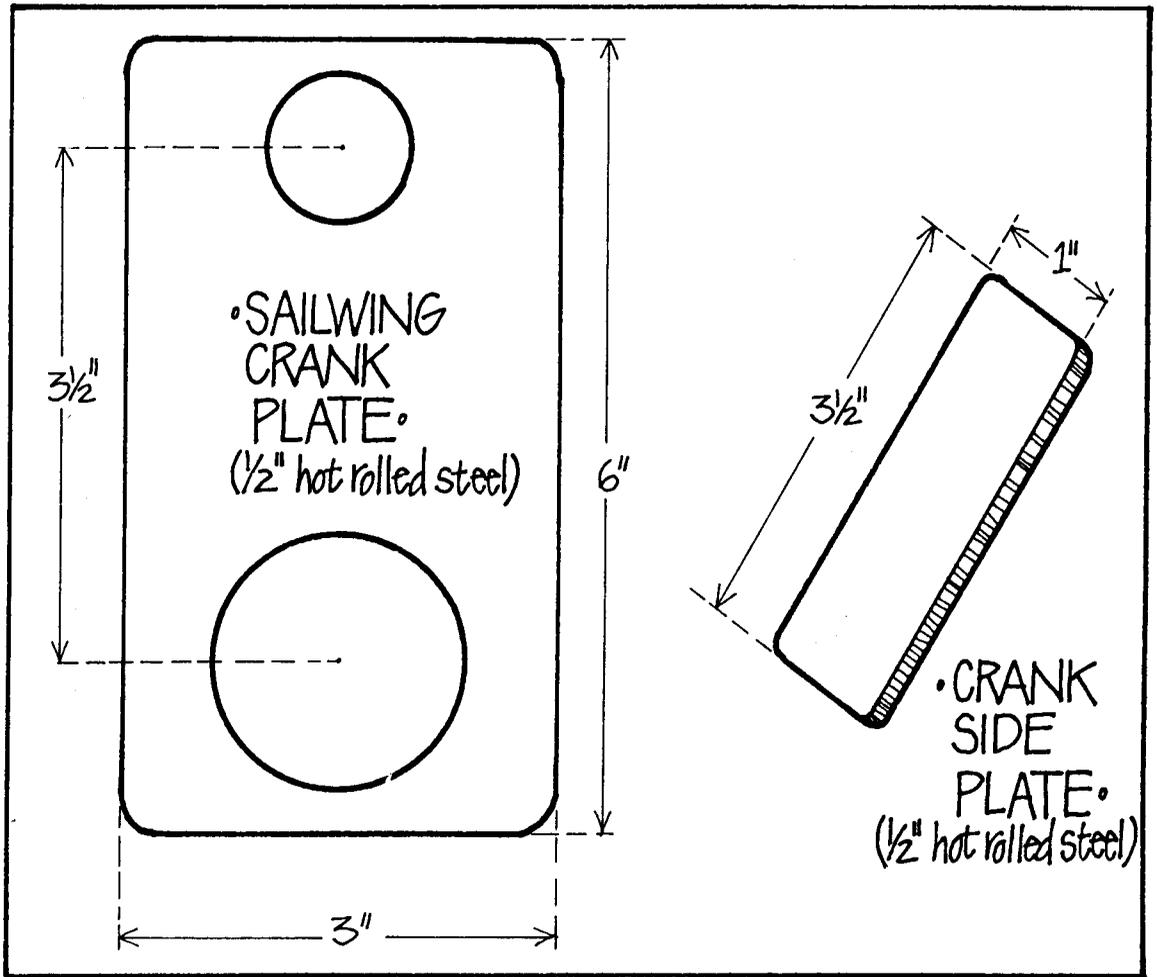

Figure 4.25. The Sailwing crank plate and crank side plate.



length (4½ inches) extends from the crank plates (Figure 4.26). Weld the shafts to the crank plates with care. Weld evenly and avoid overheating. To minimize distortion, weld the ends of the crank sides to the shafts.

When the crank has been firmly welded, hack-saw off the excess crankpin shaft and weld that seam. Press the 1-inch bearings over the crankpin as shown (See 4.15). The photo shows 1-inch pillow block bearings instead of flange bearings. We have since opted for flange bearings as a matter of convenience. The choice of each will affect the design of your pump shaft connection.

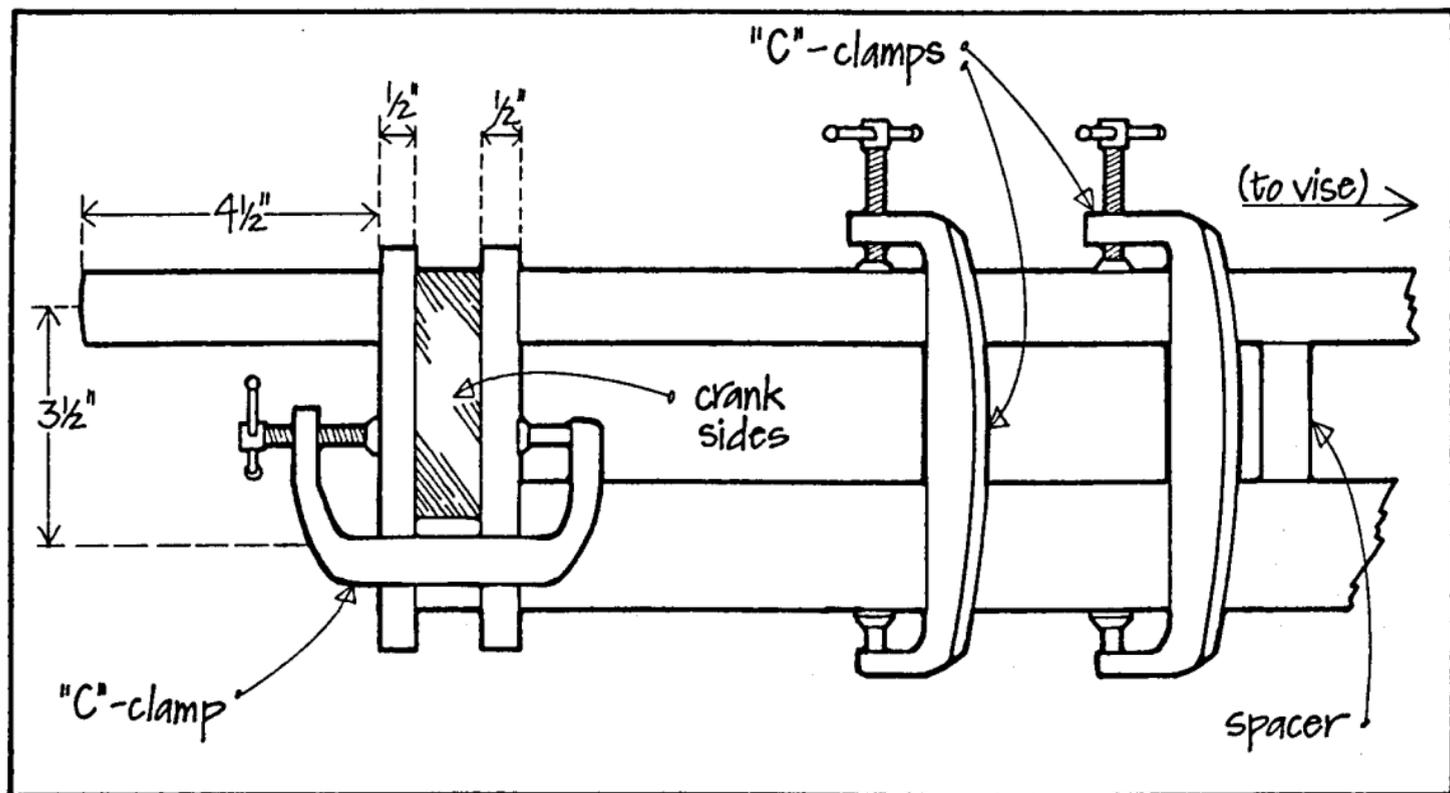

Figure 4.26. Assembling the crank.

## THE TURNTABLE

### *Parts List*

All plates should be ½-inch hot-rolled steel cut to the following specifications:

- (1) Base plate, cut to specifications given in Figure 4.28
- (1) Front (brake) end plate, cut to specifications given in Figure 4.29
- (1) Crank end plate, cut to specifications given in Figure 4.30
- (2) Front side plates, 8 inches x 11 inches x ½ inch
- (1) Rear side plate, 8 inches x 11 inches x ½ inch
- (1) Rotek M4-12P4, Series 1000, 9-inch ball bearing turntable
- (12) ¼-inch x 1½-inch hardened bolts, nuts, and washers.

### *Procedure*

Two procedures follow. The first is for mills with a turnout lever for braking, the second for mills using a rotor brake.

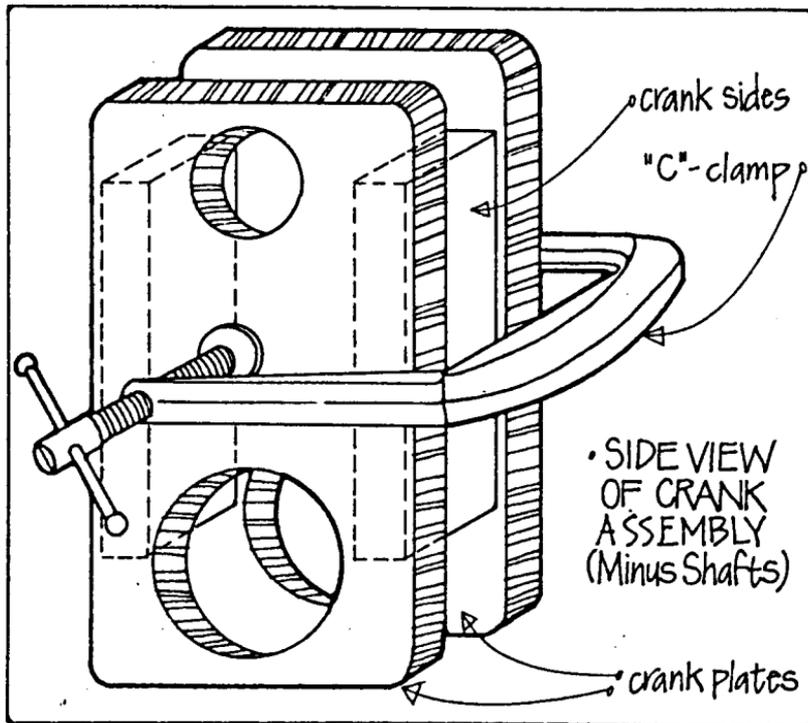

*Figure 4.27. Side view of crank assembly (minus shafts).*

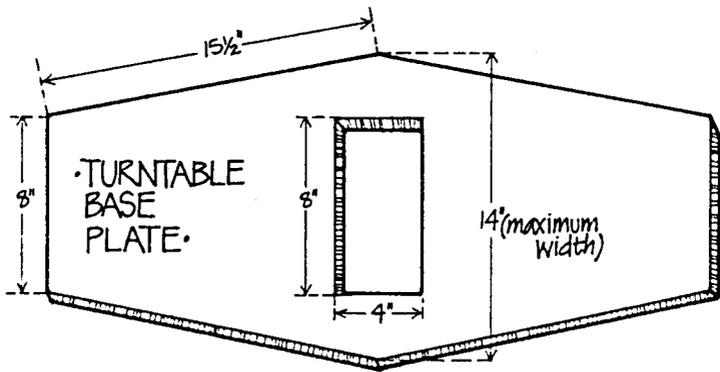

Figure 4.28. Turntable base plate.

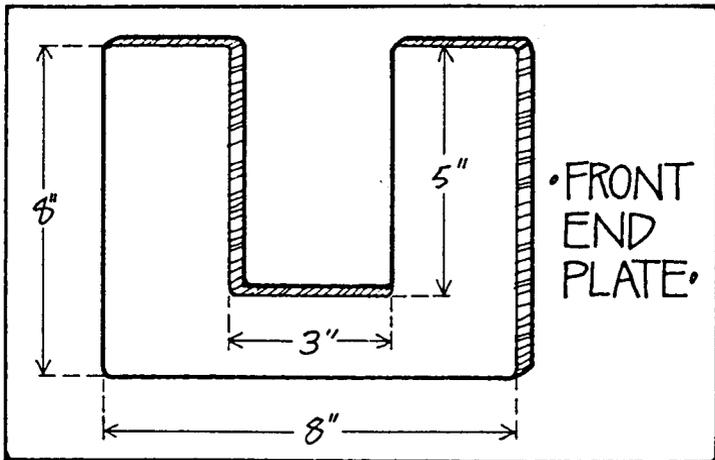

Figure 4.29. Front end plate.

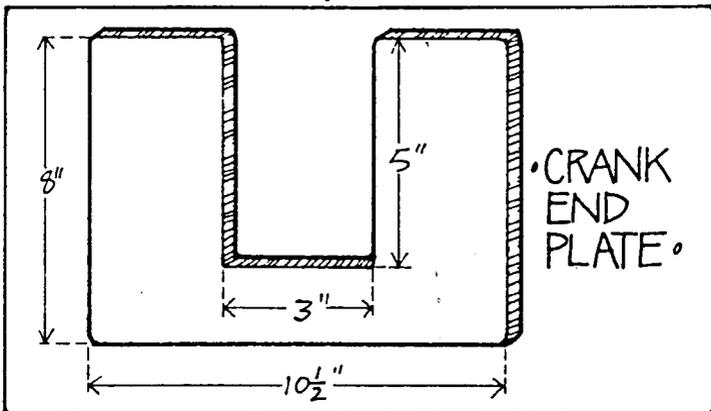

Figure 4.30. Crank end plate.

### *Turntable with turnout lever*

1. Lay the base plate flat on a work table. Center and lay the Rotek bearing upside down on the base plate. Rotate the bearing so that the two grease nipples are easily accessible from the sides of the plate. Also, be sure that no Rotek mounting holes intersect a line  $9\frac{3}{4}$  inches from the front of the base plate.

2. Drill the Rotek bolt mounting holes in the base plate, being certain that the bolts align properly, then proceed to the next step.

3. Place one of the  $1\frac{1}{16}$ -inch flange bearings in the center of the crank end plate (Figure 4.31). Drill the bearing mount holes and bolt the bearing to the plate. **Be accurate!** Measure carefully and centerpunch heavily.

4. Slide the  $1\frac{1}{16}$ -inch shaft through the bearing and stand both bearing and crank end plate on the base plate  $8\frac{3}{4}$  inches from the edge. Be sure the crank is on the opposite side from the bearing (Figure 4.32).

5. Slide the other  $1\frac{1}{16}$ -inch bearing over the shaft, so that it faces the mounted bearing. Place the front end plate in position, flush to the edge of the baseplate. Using a C-clamp, clamp the bearing to the front plate as shown in Figure 4.32.

6. Using a square, make absolutely certain that both the crank end plate and the front end plate are perpendicular to the base plate. Now check to see that the  $1\frac{1}{16}$ -inch shaft is perpendicular to the front bearing in all directions.

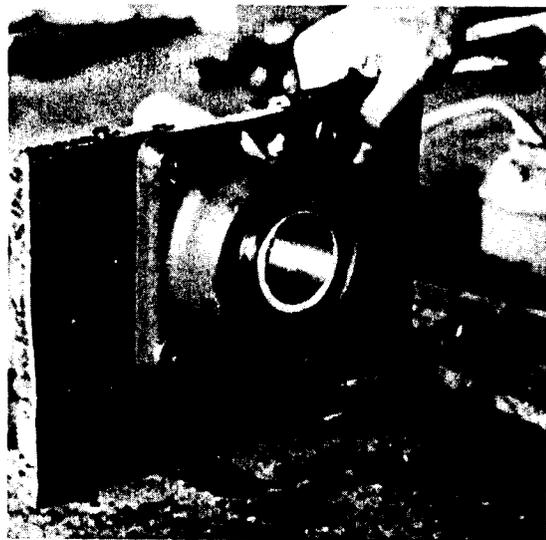

*Figure 4.31. Mounting the flange bearing on the crank end plate, or the front end plate.*

7. Once you are certain that these parts are perpendicular, mark the bearing mount holes on the front end plate. Remove the plate, drill the holes, and bolt the front end plate to the bearing. Recheck to be sure the appropriate parts are still perpendicular.

8. Tack weld the crank end plate and the front end plate to the base plate four times, two on each side. Recheck to be sure the parts are perpendicular. Place the two front side plates in place, tack weld them first to the two end plates and then to the base plate. Tack weld the rear side plate in the same manner.

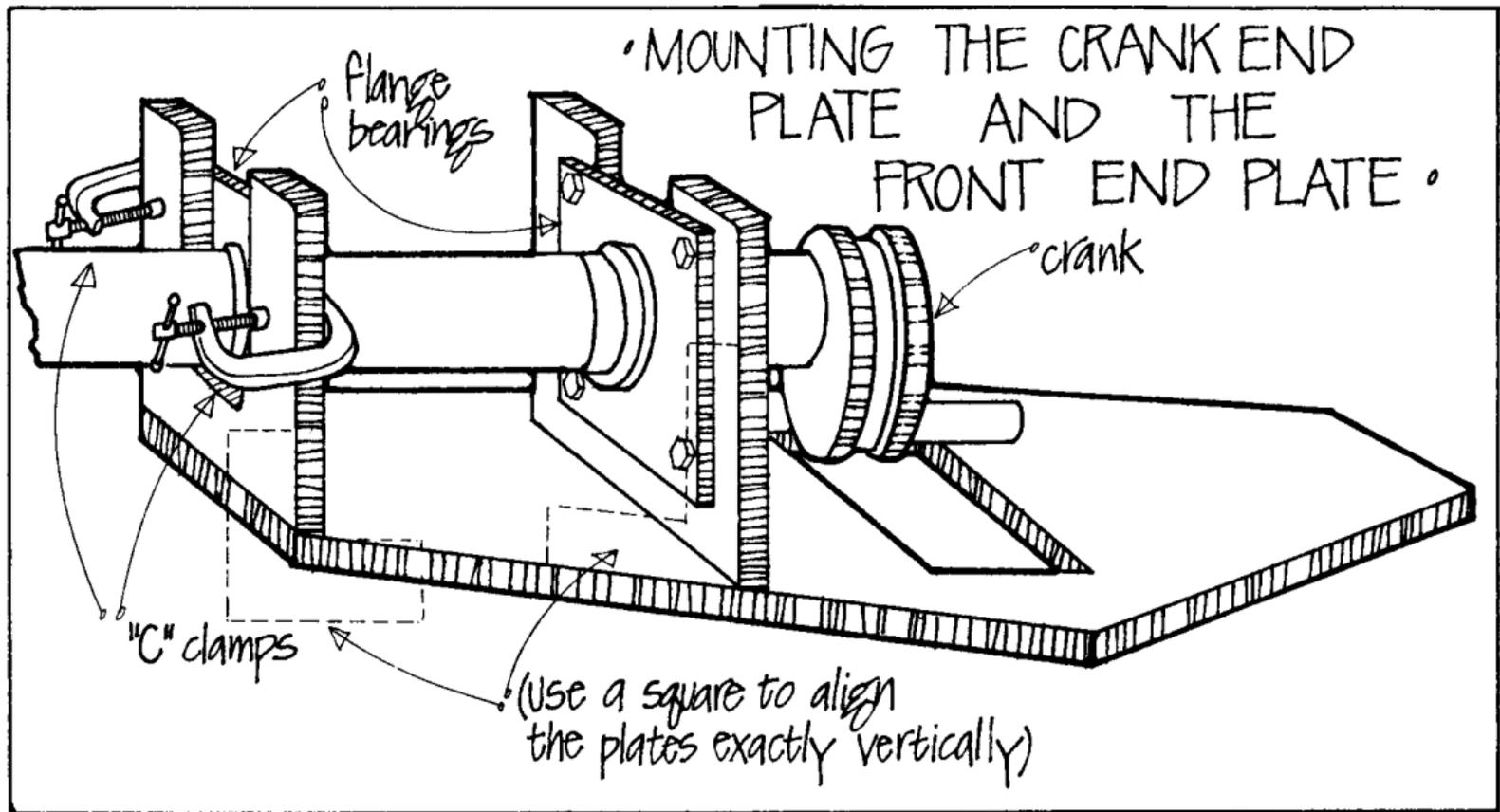

Figure 4.32. Mounting the crank end plate and the front end plate.

9. Remove the bearings (heat ruins them) and shaft and complete the welds. Be careful not to overheat the plates or they will become distorted. Coat the assembly liberally with zinc paint but avoid coating the bearings and shaft. You should end up with something that looks like Figure 4.33. Drill a  $\frac{3}{4}$ -inch drain hole in the enclosed "box," so that water does not pool, causing rust and possibly ice damage.

### *Turntable rotor brake*

1. Follow all of the steps for the turntable with turnout lever. When the welding is completed, reassemble the shaft bearings and bolt the bearings tightly to the end plates.
2. Take the automotive brake backing plate and slide it over the shaft, brake shoes toward the end of the shaft having the set screw holes. Slide



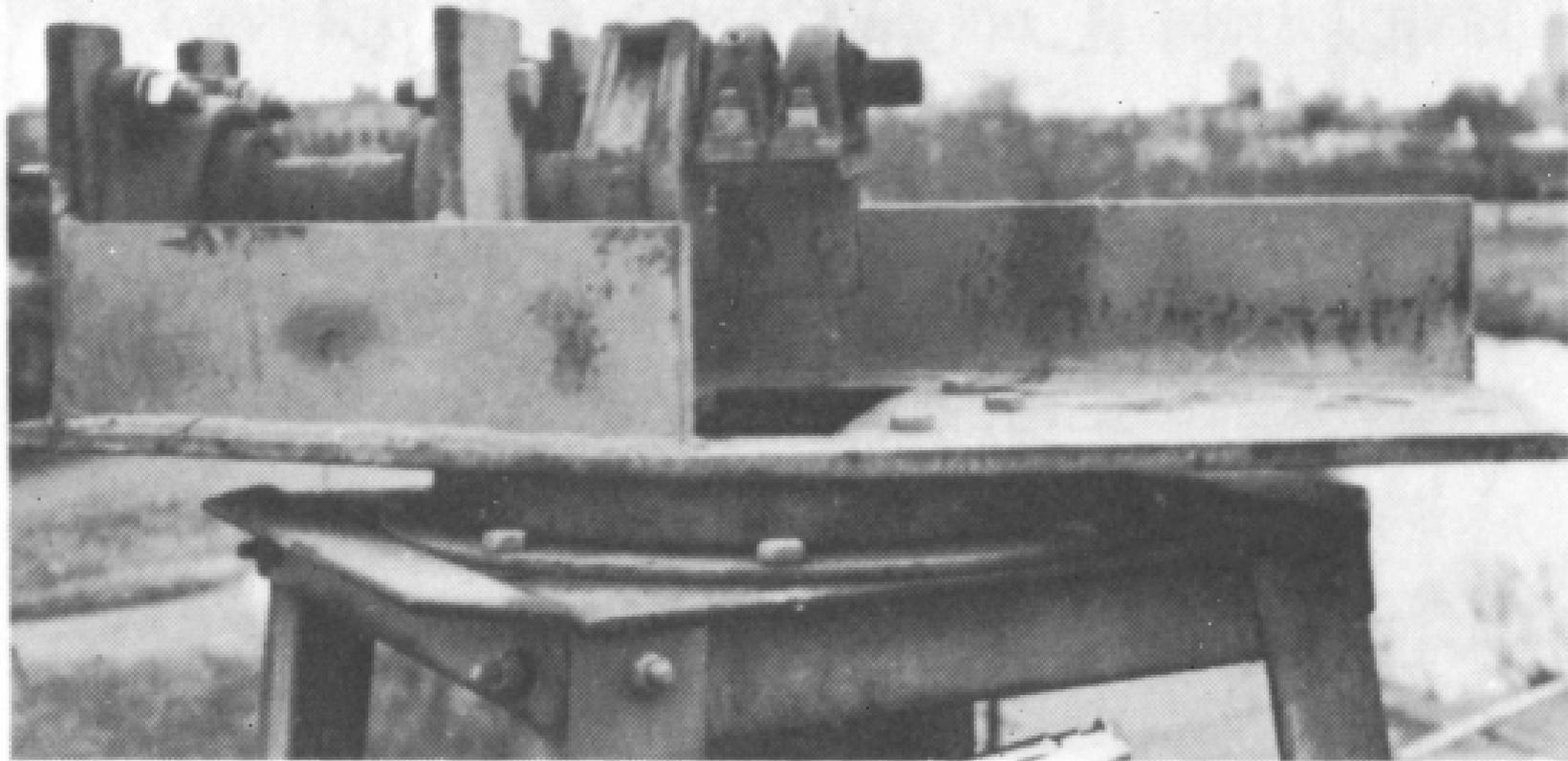

*Figure 4.33. The completed turntable.*

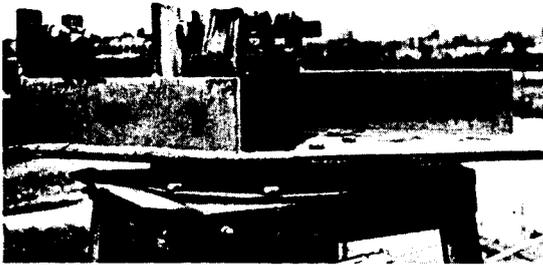

Figure 4.33. The completed turntable.

the rotor and brake drum over the shaft and slide the brake drum over the brake shoes (with the shoes retracted). Make adjustments where necessary and then drill and bolt the brake backing plate to the front end plate.

3. The brake lever is tricky and is the weakest part of our design. We employed a push rod which engages the brake by releasing a spring. The spring is actually two 300-pound springs which are released by a cable pulled from below. The lever and spring mechanism we developed is shown in Figure 4.34 and is largely a matter of common sense. Figure 4.35 shows the reset lever which is necessary to set the 600-pound tension. You will also need enough cable to reach a convenient height near ground. Attach an emergency brake lever to the vertical pump rod (next section). The cable should be set so that it is a little longer than the distance between the top (reset) lever and the pump rod lever **when the pump rod is at the bottom of its stroke**. You may

wish to position the lower lever out of reach of small children.

### THE PUMP ROD

It is extremely important to think through this part of the system *completely* before beginning, as the procedures and components will vary with different types of towers.

#### Parts List

- (1) 4-inch x 4-inch x ½-inch steel plate
  - 1-inch conduit (and fittings); enough to reach from the tower top to the well-pump polished rod
- (1) 8-foot x 2-inch x 2-inch wooden (red) rod, treated against rot
  - (1) Aermotor Pump Rod with Swivel Casting. (Aermotor Part #171B) (See Appendix.)
- (2) 2-inch x 14-inch x ¼-inch pieces of steel flat stock
  - (4) ¼-inch x 3-inch galvanized bolts, nuts, and washers
- (1) 2-inch x 2-inch x ⅛-inch angle steel, 15 inches long (for the turnout lever)
  - (1) 5-inch x ⅝-inch hardened bolt, nut and flat washer (for the turnout lever)
- (1) 4½-inch x ¾-inch steel tubing (for the turnout lever)
  - (2) ⅝-inch x 3-inch hardened bolts, nuts, lock-washers

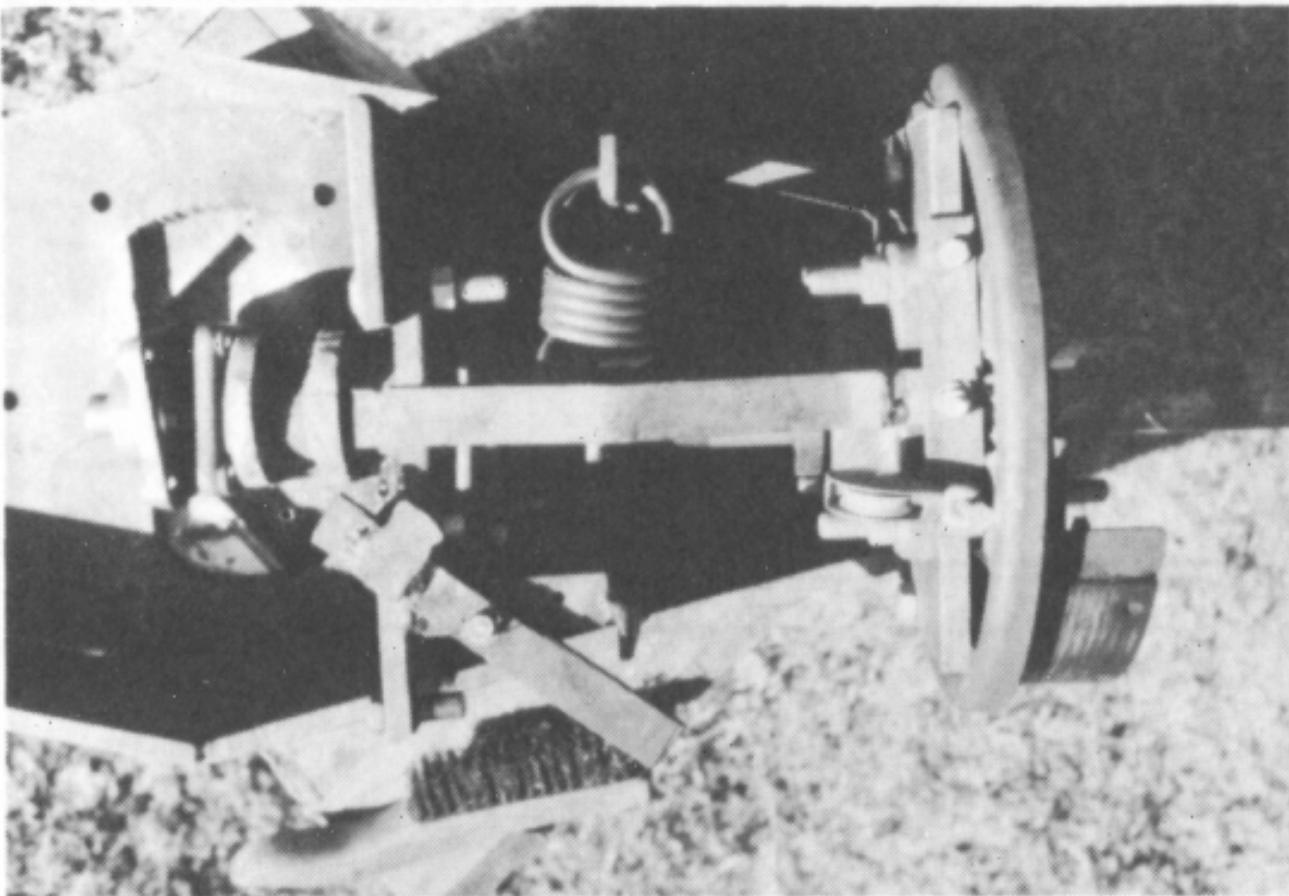

*Figure 4.34. The brake lever and spring mechanism.*



*Figure 4.35. The brake reset lever.*

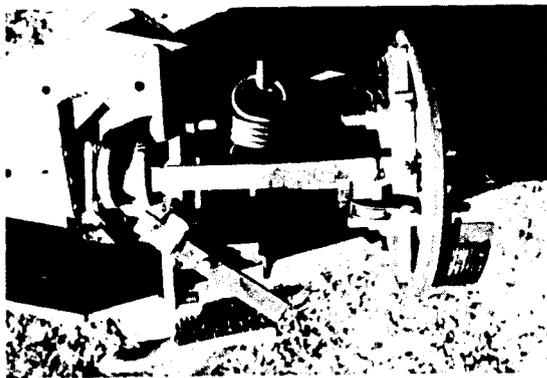

Figure 4.34. The brake lever and spring mechanism.

### Procedure

1. Lay the steel plate on the work bench. Mark and drill: (a) a  $1\frac{1}{4}$ -inch diameter hole in the center of the plate, and (b) mounting holes for the 1-inch flange bearing. Weld the plate to a 3-foot section of 1-inch conduit and coat with zinc paint. The finished product should look like Figure 4.36.

2. If you are using the turnout lever for your brake, then proceed as follows. Otherwise, continue to Step 3. Drill a  $\frac{1}{16}$ -inch hole in the end of the angle steel. Mark a point 7 feet from the end of a 10 foot section of conduit. Weld the angle steel so that it is perpendicular to the conduit at that point, making sure that the face with the hole is horizontal (Figure 4.37[A]). Slip the  $\frac{1}{16}$ -inch bolt through the hole, so that the threaded end is pointing toward the long end of the conduit. Slip

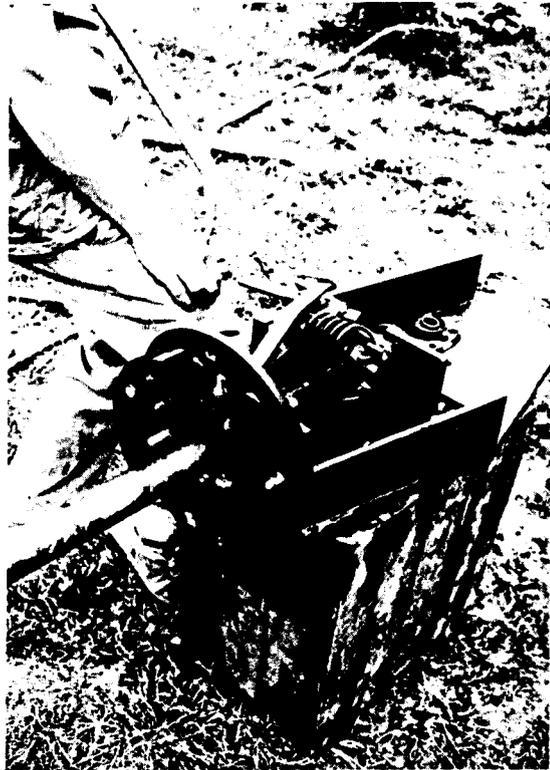

Figure 4.35. The brake reset lever.

the steel or brass tubing over the bolt so that it covers a few of the bolt threads. Slip on the flat washer and the nut and tighten firmly against the tube. It should now look like B in Figure 4.37.

It is important that the handle be located 7 feet from the end of the conduit, so that when the conduit hangs from the crankshaft, the operator can



Figure 4.36. The pump rod connector should slip over the 1-inch shaft and be "sandwiched" between the flange bearings.

easily reach the rotor tip, to hold the rotor. The handle should also extend to a point that allows the operator to reach it when standing *inside* the tower. Before you weld the angle steel, you should "eyeball" the situation to ensure that both criteria are met. The location will, of course, vary from tower to tower, but you may be forced to position the handle higher or lower on the shaft as the situation requires.

3. Take a piece of the flat stock and center it against the end of the wooden rod (Figure 4.38). Bend the flat stock so that it makes a "U" around the end of the rod. Clamp the steel to the rod, drill a  $\frac{3}{8}$ -inch hole through them both, and bolt the

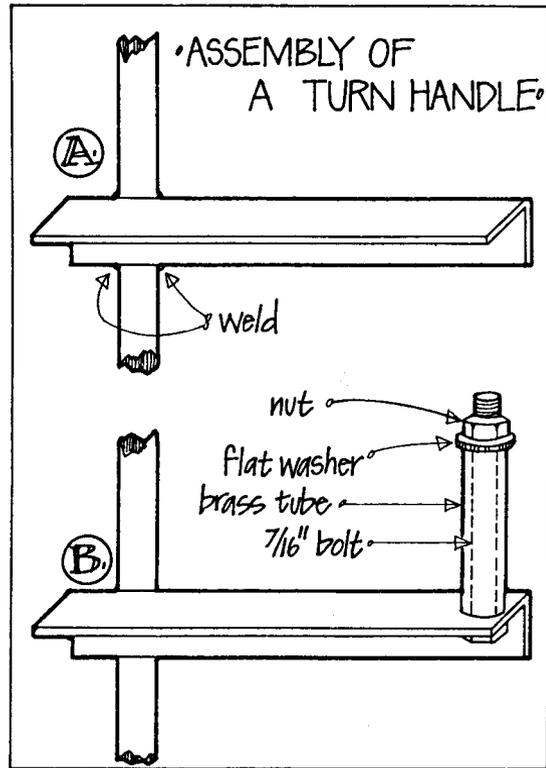

Figure 4.37. Assembly of the rotor turnout handle.

two steel faces so that they sandwich the wood rod. Take the other sheet of flat stock, lay it perpendicular to the first, and repeat the procedure. Remove the bolt and separate the wooden rod from the steel enclosure.

4. Weld the two pieces of U-shaped flat stock together where they intersect. Then, weld the flat

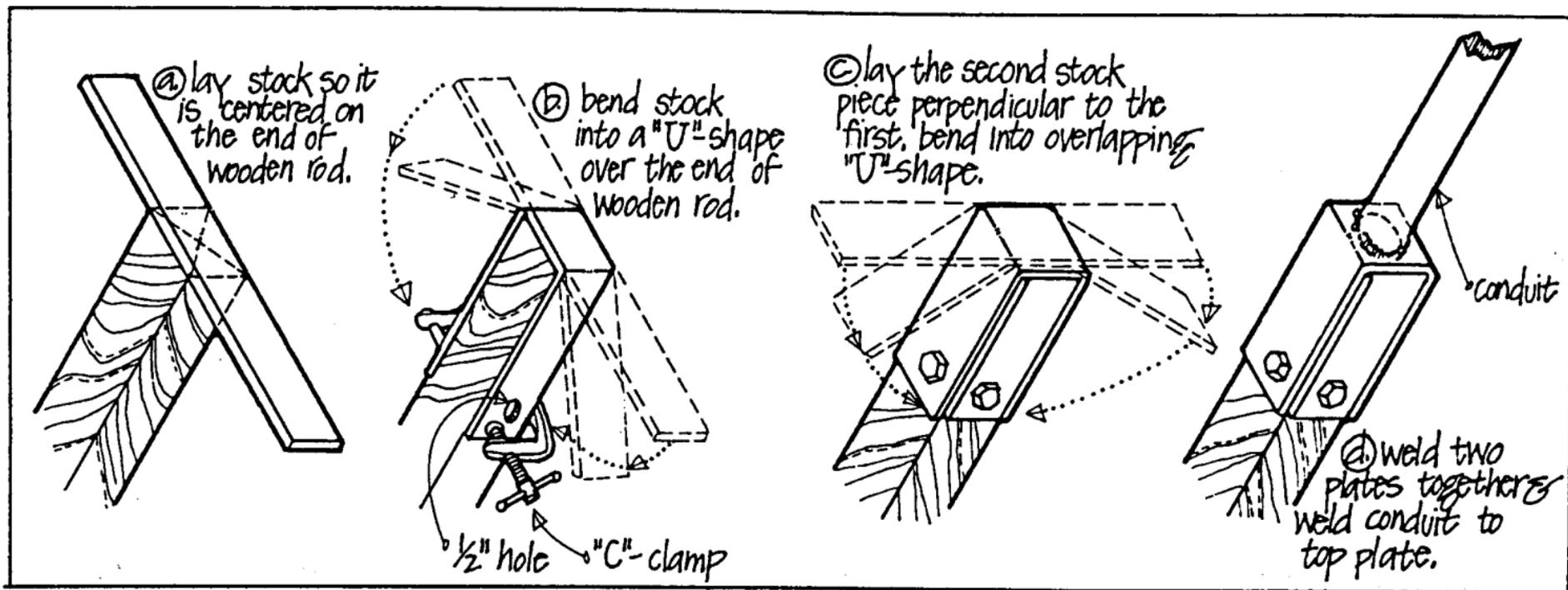

Figure 4.38. Assembly of the red rod connector. (a) Lay the stock so it is centered on the end of the wooden rod. (b) Bend it over so that it forms a "U" to the shape of the wooden rod. (c) Lay the second piece per-

pendicular to the first and repeat, overlapping the top of the first piece. (d) Weld the two plates together, and weld the conduit to the top plate.

stock "sandwich" to the end of a 10-foot section of conduit as shown in Figure 4.38.

5. Take the Aermotor swivel shaft and saw off the flared nipple. Thread the shaft and the top of your well-pump polished rod, so that they can be joined.

The next few steps are performed once the windmill rotor and turntable are secured on top of the tower and when the well, pump, packer head, and polished rod are in place. See Chapter 5 for instructions on erecting the windmill and installing the pump.

6. Slip the pump rod connector plate over the 1-

inch crankshaft and sandwich it securely between the two flange bearings (Figure 4.36). Bolt and tighten the bearings/plate "sandwich." Loktite® all bolts.

7. Connect the section of conduit with the brake handle next. The 7-foot section should be on top. Screw on a conduit coupling and use Loktite® on the threads to prevent the threads from reversing and coming apart.

8. Connect the remaining sections of conduit until the pump rod hangs 22 feet above the packer head. At this point, connect the piece with the U-shaped flat stock, so that the flat stock hangs down.



9. Connect the wooden red rod.

10. Attach the Aermotor swivel, with the casting.

11. This next step is *very important* for the safety of your pump. Before you connect the swivel shaft to the polished rod, make sure that the crankshaft and pump shaft are at the bottom of their stroke. Now, make sure that the polished rod is lifted vertically 2 to 3 inches to ensure that the plunger does not rest on the lower check valve in the pump cylinder down below. If you do not built in the 2- to 3-inch clearance margin, the plunger will jam against the bottom check valve, resulting in costly damage to several components. Feel free to saw off pieces of the wooden red rod to adjust the swivel shaft for proper height.

#### PUMP SHAFT GUIDES

On tall towers it is useful to employ guides so that the shaft does not wobble. The guides will differ with every tower, and most new towers come with a set for every 25 feet of height. If you need to make a pair of guides, be sure to allow for the requisite shaft swivelling mobility. You may need to install the swivel at the top of the tower to accommodate your circumstances.

#### COMPONENT COSTS

The cost for the windmill described in the previous section breaks down as presented in Table 5 (January 1, 1981 prices, Cape Cod, Mass.). We assume a 40-foot tower.

Please remember that these figures do not reflect the cost of the tower, tower adaptor, pump, pump system, or well. These components will cost the same whether you use a Sailwing or a commercial windmill, and are not appropriate for this analysis.

#### A TIRE PUMP FOR LOW LIFT AND HIGH VOLUME

The design of the New Alchemy tire pump arose from a very low-head pumping requirement. We needed to recirculate water in a closed-loop "river" consisting of three cement ponds at descending levels connected by spillways. The height from the lowest to the highest pond is less than 3 feet, so the lift requirements are extraordinarily small — roughly what one encounters for ditch irrigation.

The power from a windmill turbine translates into the product of flow times pressure. With a head of under 3 feet, say 5 feet after flow losses, the potential for moving large volumes is tremendous. But then displacement enters the picture. We estimated that the power from the Sailwing should be sufficient in an 8-to-10-mph breeze to move 30 gallons per minute. Even with no gearing down, an estimated 30 rpm of the rotor implied 30 strokes per minute, or about 1 gallon per stroke. Standard pump cylinders do not come that large. We finally decided to design a diaphragm pump using a boat trailer tire.

A detail of our tire pump is presented in Figure

**Table 5. Cost Breakdown for Sailwing Windmill**

**Rotor**

Rotor conduit	\$ 47
Rotor steel, cut to size	10
70-foot wire rope guywire	16
24 drop forged cable clamps	9
Miscellaneous rotor hardware	28
Shock cord	7
Three sails @ \$47.50 each*	143
Paint	9
Tape and Lok-tite®	<u>12</u>
<b>Total, Rotor</b>	<b>\$251</b>

**Crankshaft**

Two 1 <sup>1</sup> / <sub>16</sub> bearings @ \$40 each	\$ 80
Two 1-inch bearings @ \$20 each	40
3-foot x 1-inch steel shaft	12
30-inch x 1 <sup>1</sup> / <sub>16</sub> steel shaft	33
Crankshaft steel, cut to size	11
Miscellaneous hardware, welding rods, etc.	<u>12</u>
<b>Total, Crankshaft</b>	<b>\$188</b>

**Turntable**

Hub steel, cut to fit	\$ 47
Rotek ball bearing turntable	256
Mounting bolts	13
Paint	<u>12</u>
<b>Total, Turntable</b>	<b>\$328</b>

**Pump Rod**

Steel, cut to fit	\$ 13
Conduit (30 feet)	24
Red rod	8
Aermotor swivel	29
Miscellaneous hardware	<u>20</u>
<b>Total, Pump Rod</b>	<b>\$ 94</b>

<b>Grand Total Without Brake</b>	<b>\$861</b>
Turnout lever	14
Rotor brake	27

\* Price Quoted by North Sails East, October, 1980, based on set of four sails @ \$190. It's good to have an extra sail on hand.

4.39. The rigid shaft drive train and crank are detailed in Figures 4.40 to 4.43. The overall design is not "mature and ready to ship." Things still break too frequently. We are learning how to build this pumping system to last, and we invite you to look in on the process. Those of you who wish to build a tire pump must understand that at this point the procedure is far from cut-and-dried. You will need to understand the principles involved, for you will be joining us in the design process and can expect failures and hassles as well

as the reward of exploring new territory. There are no plans offered for the tire pump in this book. What appears in this chapter are principles and ideas — all we can offer to date.

**THE PUMP**

We chose the tire size to give the desired displacement with moderate stretching of the sidewalls. Marcus Sherman gave the current design team (Gary Hirshberg, Joe Seale, Jay Baldwin, Mac Sloan) the original idea for the pump, but his

prototype was too large (the tire was about pickup-truck size) to suit our needs. Marcus cut the middle out of a truck wheel, leaving the two steel rims that fit the bead of the tire. He then welded  $\frac{1}{4}$ -inch steel plates to the tire-fitting rims to make end-pieces for the pump. Holes were drilled with roughly 1-inch spacing through the tire and rim, securing the perimeter of each tire

bead to a rim and end plate with nuts, bolts, and washers. We do not know if his detailing would work (probably so) or last very long (probably not). The cross-section of the large tire was much too large for a 20-foot Sailwing to move even a  $\frac{1}{2}$ -inch stroke under hydraulic load. However, there is something valuable in the idea of using an existing tire rim of proper shape to capture the tire

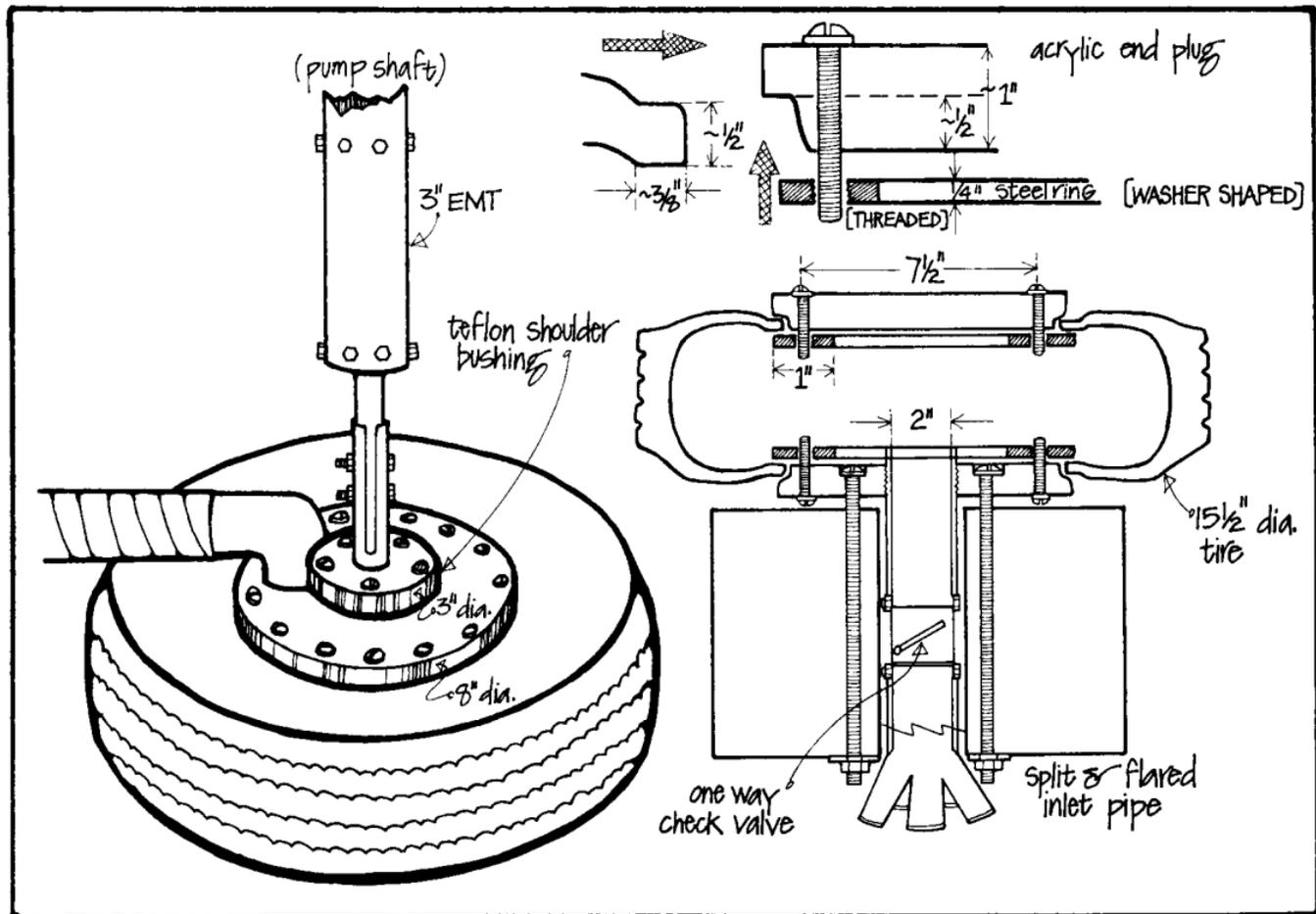

Figure 4.39. A detail of the NAI tire pump.

bead. We did that part the hard way — from scratch, with acrylic plastic turned on a lathe. We used acrylic so we could see into the pump as it worked.

The result of our effort with acrylic is illustrated in Figure 4.39. That part of the design has worked very well for four pumping seasons and should go many more. The tire is drawn securely into contact with the acrylic disc by nuts and bolts, much as in Sherman's design, except the bolts do not penetrate tire rubber. The washers that spread the load on the inside of the tire bead in Sherman's design are replaced by two large, flat, washer-shaped steel rings which press the bead onto the beveled acrylic discs.

The tire must be a road tire with a thick tread, not a balloon tire or aircraft tire. It must tolerate significant suction without collapsing inward. Radial ply tires would probably be more prone to collapse on the suction stroke than ordinary bias ply tires. Tires with worn treads are probably a bad idea. A brand new tire, not broken in by road use, is probably worth the investment.

We started with a 2-inch inlet pipe and a 2-inch outlet pipe, each with one-way check valves. Although the lift height was small, suction to overcome flow resistance in the inlet pipe and valve caused the tire tread to buckle inward in moderately high winds. Adding a second inlet pipe and valve for easier flow helped considerably, but the tire was so weakened by repeated buckling inward that even the two inlet pipes did

not give sufficiently low flow resistance. Figure 4.39 indicates one alteration that would further reduce flow resistance — splitting and flaring the ends of the inlet pipe to avoid some of the turbulent flow separation that takes place at the pipe orifice. We believe that splitting plastic pipe into about six flared "petals," kept flared by a wired-on steel ring at the lowest point, would provide a substantial improvement in flow. (A smooth flare would work better than "petals" if that were easy enough to accomplish.) To be on the safe side, we suggest two or even three flared or "petal" inlet pipes no greater than 2 feet in length to be certain not to collapse the tire at high pumping rates.

#### THE PUMP SHAFT

We used a shaft in compression for the power stroke. There is a good reason why most water pumps use a tension shaft — shafts tend to buckle under compression. We estimate a peak compression load of more than 1,500 pounds on our shaft in high winds. The shaft is large. It consists of 3-inch EMT® conduit. If you look at engineering formulas for buckling strength of a tube, you will see that strength increases as the cube of diameter when wall thickness remains constant, but increases only linearly as wall thickness increases. That explains why we use relatively large-diameter, thin-walled tube for buckling strength. The formulas also tell you that buckling force varies inversely as the square of length, so do not try to use a shaft longer than 30 feet if you want to copy this design.

EMT<sup>®</sup> tubing is available in 20-foot lengths. To join two sections rigidly to obtain a roughly 28-foot shaft for our mill, we split an entire 20-foot length of tubing along the seam (with a saber saw — a nasty job) and pried it open to slip two lengths inside. To the right of the shaft illustration in Figure 4.40 is a to-scale illustration of a fixturing piece of metal cut from  $\frac{1}{16}$ -inch steel. This piece can be grabbed with vice grips, inserted in the cut seam and twisted to pry the seam open. After inserting about four such pieces the narrow way along the seam, a fifth piece is inserted the wide way, causing the first piece to fall out. This first piece goes in the wide way to replace the second, and so forth, until the entire tube is split open about an inch. The tubes to be joined are then slipped inside the split tube. A number of large hose clamps pull the split tube tightly down onto the two inner pieces, and steel pop rivets complete the joining job. After pop rivets hold the two inner tubes and sleeve tube together securely, the hose clamps may be removed and reused.

### THE TRANSMISSION

Bearings that work with a flexible tension pump shaft are usually not acceptable with an extremely stiff shaft. The crank arm must be absolutely parallel to the rotor shaft axis and accurately perpendicular to a plumbed stiff pump shaft. A flexible red rod as is typical in a conventional water pumper will forgive several degrees of

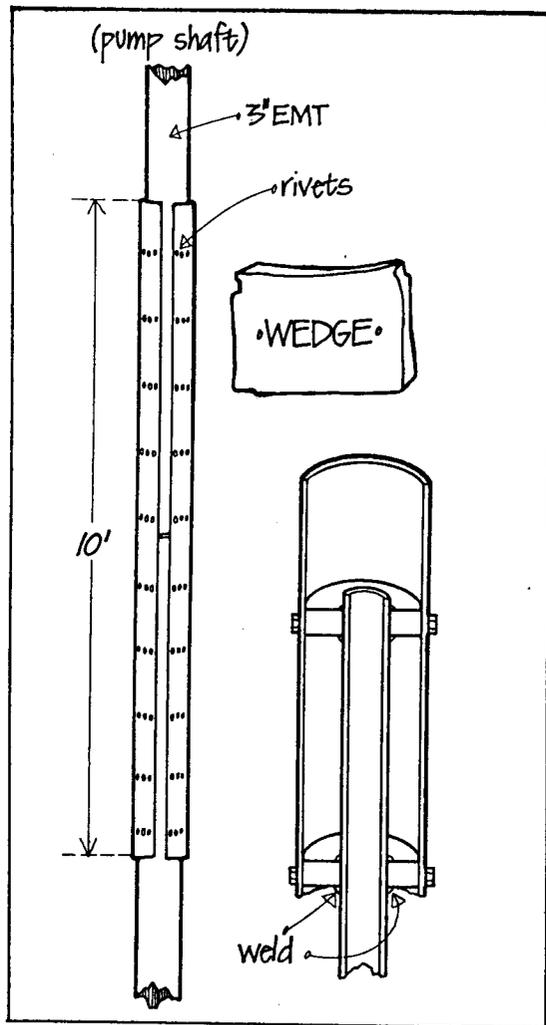

Figure 4.40. The high-compression, rigid EMT<sup>®</sup> shaft.

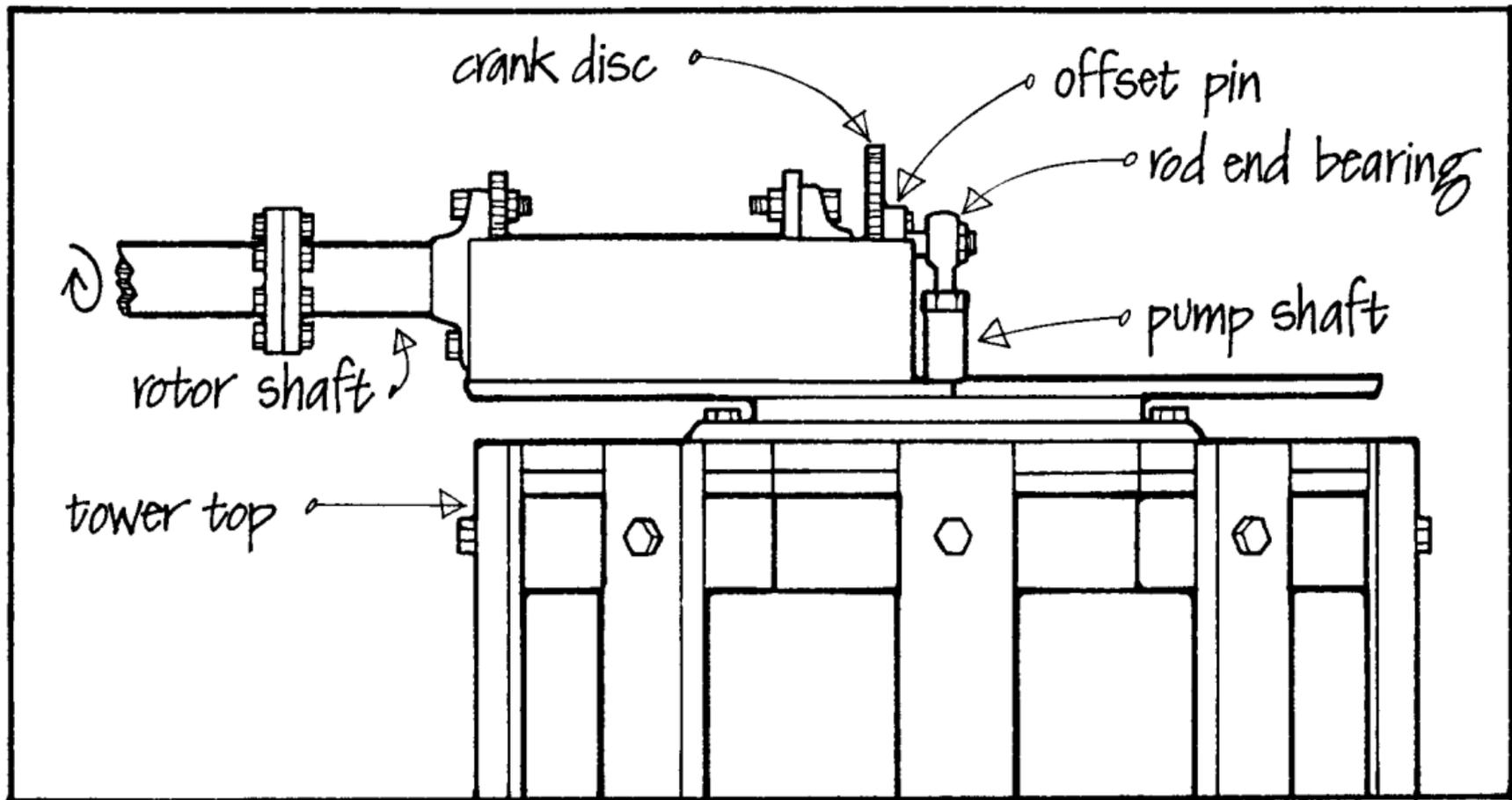

Figure 4.41. Side view of the crank on the Big Red turntable.

misalignment. Bending the EMT<sup>®</sup> shaft even one degree will create serious bearing wear using the two flange bearing design illustrated in Figures 4.31 and 4.33. The two flange bearings would also need to be very precisely opposed to define an axis perpendicular to the shaft. Unless you know what you are doing and have a well-thought-out alignment procedure for the turntable bearing plane, crank arm attachment, and flange bearing attachment, you will get into trouble with a stiff shaft. If you think you can achieve the overall accuracy described (one degree cumulative error),

the crankshaft configuration described earlier will be helpful.

In this application, we used a rod end for the top bearing. An unmodified rod end will be ruined as the rotor yaws and causes the rotating crankpin to touch the edges of the spherical bearing cavity. We used a thick nylon washer rotating with the crankpin and bearing on the side of the rod end, as shown in Figure 4.41, to keep the rod end rotated for approximate alignment with the crankpin. The nylon washer wears down about 1/32-inch per month, so compensating spacer



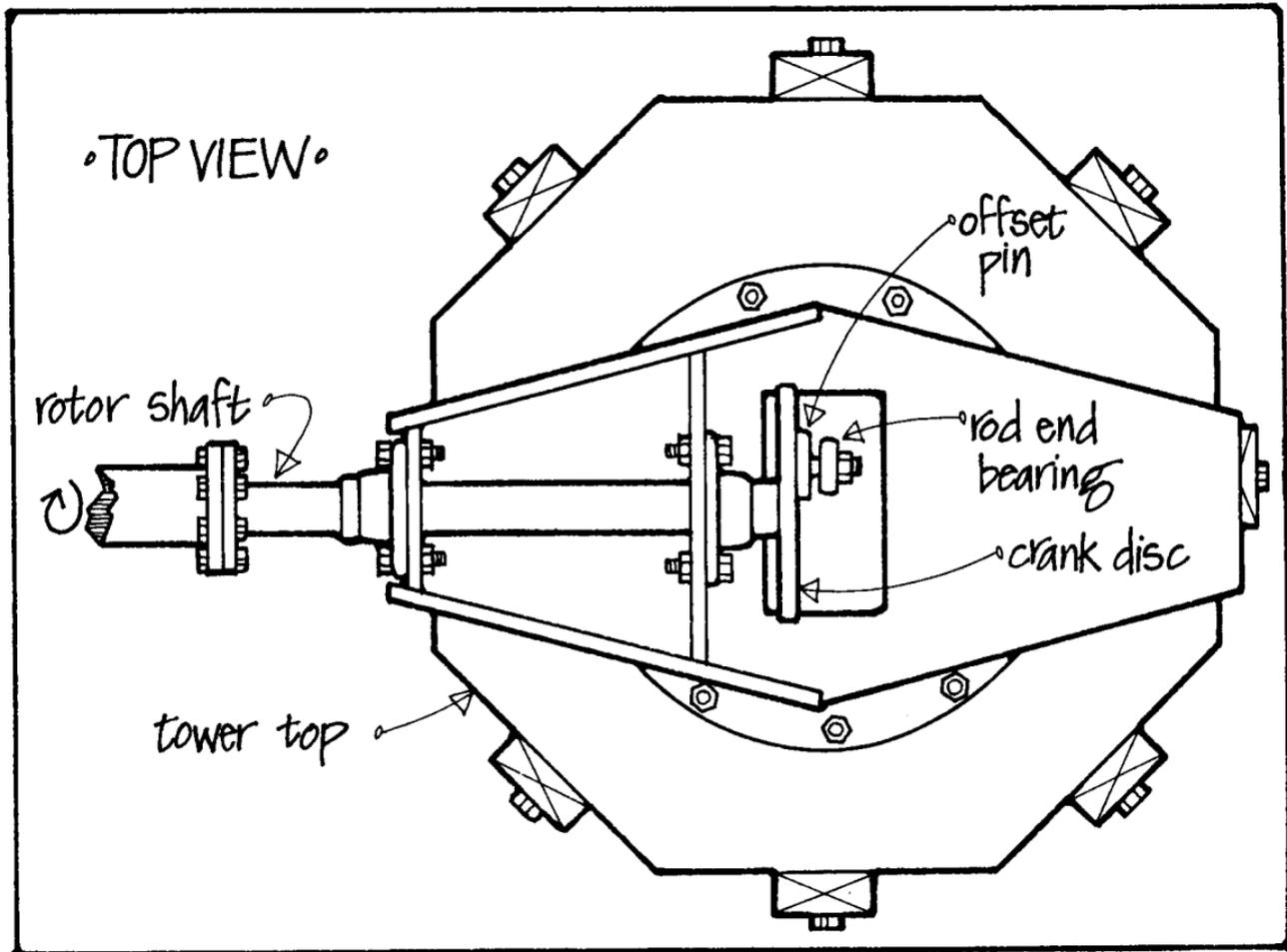

Figure 4.42. Top view of the crank.

washers have to be added about every two months. Although this custom-modified rod end assembly was built as a temporary solution to a problem, we have lived with it for three years, with a complete replacement after the first two years.

## THE SWIVEL

The swivel on the shaft has to withstand tension, large compression, and rotation. We used a Teflon shoulder bushing at the tire pump. The swivel can be at the top of the shaft, integrated

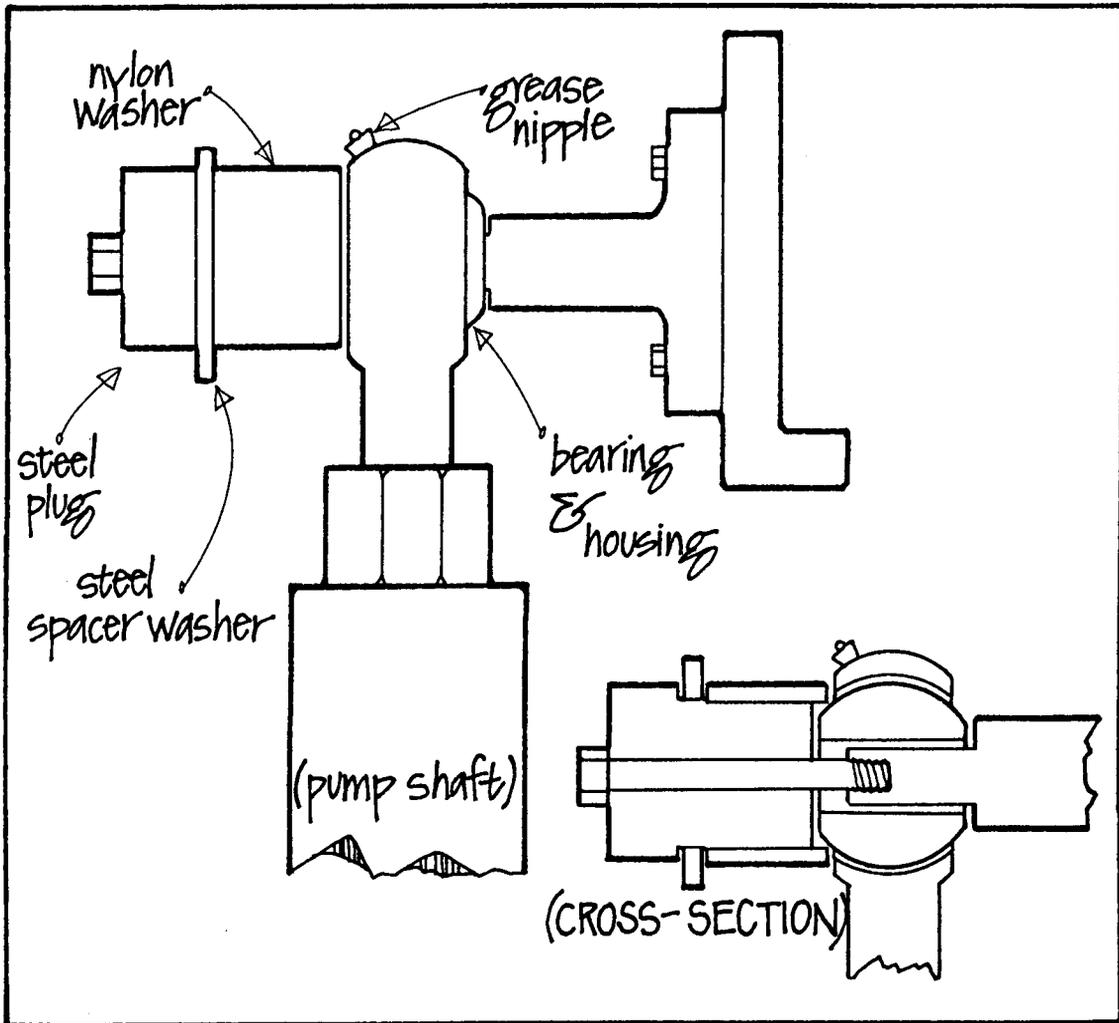

Figure 4.43. Crank detail.

into the bearing assembly, or it can be at the pump. If it were in between, the swivel would become a point where the shaft tries to buckle. We have no off-the-shelf substitute for this custom swivel.

Beware of a long water column at the pump output. Our mill has to push water through about 20 feet of 2-inch pipe, which develops tremendous back pressure on the downstroke. An air reservoir with a snifter valve very near the pump can smooth out the pump load and lessen pipe friction. A shorter pipe or a larger-diameter pipe would be highly desirable. With a very short or large outlet pipe, the shock-absorbing reservoir is unnecessary.

Joining smaller pipes to the large EMT® is tricky. EMT® is too thin to weld (without direct current (DC), inert atmosphere, and skill). The end joints consist of annular discs (Figure 4.40), tapped for bolts that hold the discs in the EMT® shaft. The smaller joiner tube is welded to the inner diameters of the discs.

As of this writing, the tire pump is still a relatively immature design. It definitely does its appointed job well and with good engineering the design should become durable and reliable. The biggest problem with the design is its short stroke — 3½ inches. Longer strokes require smaller forces for equal energy transfer. The short stroke is directly compatible with simple direct drive from an offset crank with an expensive but afford-

able turntable bearing. Thus, the tire pump suits our overall windmill design.

## JIM JACOBS'S SAILWING

The NAI Sailwing is a good, proven design. After six years of development, we feel it is ready to be employed in the form described here. However, there will always be room for improvements in virtually every aspect of the Sailwing's design. Many readers will want to tinker and experiment, practices which we heartily endorse. For that reason, this section includes a detailed description of one group of tinkerers' efforts to improve on the basic NAI design.

United Energy Works, Inc., of Virginia Beach, Virginia, is a small manufacturing firm interested in the design and marketing of home-scale solar and wind energy devices. The company's founder, Jim Jacobs, is a devoted tinkerer, and a long-time friend of the New Alchemy Institute. His goal to develop and market an excellent, first-class sailwing windmill in kit form first caught our attention almost a year ago. Since then we have followed his progress with great hopes and affection, and have highlighted several of his progress reports here. Jim's comments are followed by some brief critiques by two of New Alchemy's technical wizards, Joe Seale, an electrical engineer, director of Wind Research at NAI, and Jay Baldwin, soft-tech editor of *The CoEvolution Quarterly* and *The Whole Earth Catalog* series.

August 8, 1980

Dear Gary,

I have formed a new company (about mid-May), which I hope will come to be known as United Energy Works, to manufacture, promote, and distribute windmills, the primary one being a sailing. (Figure 4.44) . . . As you no doubt noticed in the slides, I have drawn upon the New Alchemists for inspiration, background, and advice (drawn from your journals) in some of my design for our sailing. However, you will also have to agree that the design is not the same, as we have spent much time, money, and research in trying to simplify and improve upon the basic idea. I wish to pay my respects to your group for all that it has done in preserving the ancient knowledge and beginning the updating process again.

. . . Our intention is to produce the mill in kit form. We plan to complement the kit with attachments which we are developing, such as a wood-cutting buck-saw, a gristmill, an air compressor, and possibly a heater (turbid air type). Water pumps we plan to handle from a variety of manufactured sources, as well as stock Navy surplus when we can run into a good bargain. Our long-term resolve is to be around for quite a number of years to make the components, spare parts, and improvements in design.

. . . As you noticed from the small sample I had, our sail has a nice "cut" to it. We have analyzed it as best as our present ability permits. However, I indicated we would try to use the wind tunnel where I teach to make it even better. Our use of acrylic, for example, is a beginning along this line of searching for the best — at a price, I hope, we can still call reasonable . . .

. . . We are not planning on advertising. We believe that another form of getting the word out is the best way for us to go. It will take much longer, and possibly



Figure 4.44. The completely erected windmill with Jim Jacobs standing at the base.

advertising will come someday, but that's far in the future. Word of mouth and reputation will be (ultimately) adequate.

I look forward to future exchanges.

Yours,

Jim Jacobs

September 15, 1980

Dear Gary,

Since we last spoke, a number of changes have occurred in our design. A second prototype is under construction now, and I hope we will have it up in a few weeks. There are a sufficient number of differences that I thought you might find interesting, and possibly the readers of your forthcoming book will find them intriguing. They might wish to incorporate some of the features on "mills" they might build.

The first change, and probably the most profound, is that we have gone to a very inexpensive thrust bearing upon which the upper platform rotates. We are using a 4-inch pipe (about 9 inches long) and a 3½-inch pipe (about 12 inches long) which turns inside it (See Figure 4.45). The main platform which supports the bearings, shaft etc., is welded to the 3½-inch pipe. A bronze Oilite® bushing and continuous grease feeders provide rather easy turning, but not so easy as a ball bearing, which as you might remember, I am dissatisfied with because it allows the upper turntable to "dance" in rapidly changing winds, which places undue stress on the individual booms.

Possibly the sketch is more intelligible if I also mention we have designed the windmill to be placed atop a telephone pole. The reason is strictly economics. We can get a 50-foot, salt-treated straight Class 4 pole for

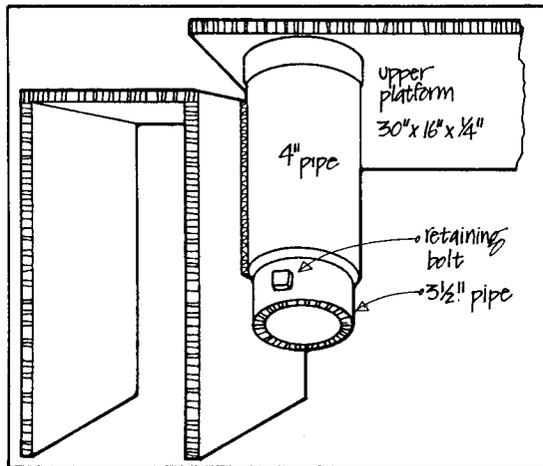

Figure 4.45. Jim Jacobs's turntable bearing.

about \$250 delivered to site; 60- and 70-foot poles are also available, which for most sites around here (and around the country) is quite adequate. We plan to use ½-inch stainless aircraft cable (1,700 pounds working strength, though we may go ¾ which is 2,400 pounds) and the Nicopress® system of putting them together. With foundation, three guy wires, and a few friends (plus car) to help raise the pole, we can erect a 50-footer for about \$350. That's only \$7 per foot and the poles may well last fifty years. We reasoned that others across the country would have more access to poles (they can get them from utilities or even cut their own), which might make it a more universally acceptable and more appropriately low-scale technology than a steel tower.

As far as the sails go, we are trying a special Nylon strap to bind the sails to the mast (Figure 4.46) so as to increase aerodynamic efficiency over the NAI design. By allowing the sail to twist on the boom (which it

really wants to) a smoother surface can be attained, more like an airfoil. We have even speculated on the effects of a plastic molded leading edge which would also clamp the sail and be able to turn around the boom (Figure 4.47). We may make a model of this and try to test it in the wind tunnel.

And lastly, we have devised a way to allow the sailing tips to be at a steep angle of attack (good starting in low winds) and flatten out as the wind speed increases, allowing higher rpm. And it even acts as a brake if the speed gets going too fast. We are trying to patent the feature so I can't say more than the above. Our patent, by the way, is not viewed as some sacred, proprietary right from God, rather as a necessity in today's business world. It is an accepted form of sanction (as viewed by the public) and little more than public relations for us.

As I think I once mentioned, probably in the last letter, our aim is to produce an excellent, relatively low-cost machine which can serve as a primary wind engine, and then to develop good accessories to go along with it: pumping water, sawing wood, generating electricity, grinding grain or compost, etc.

Yours,

Jim Jacobs

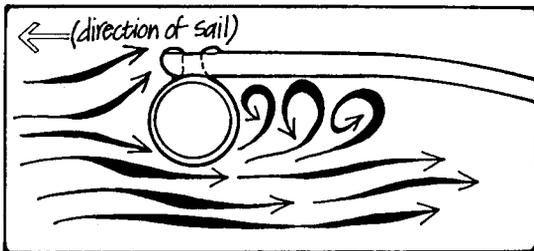

Figure 4.46. The nylon strap binds the sails.

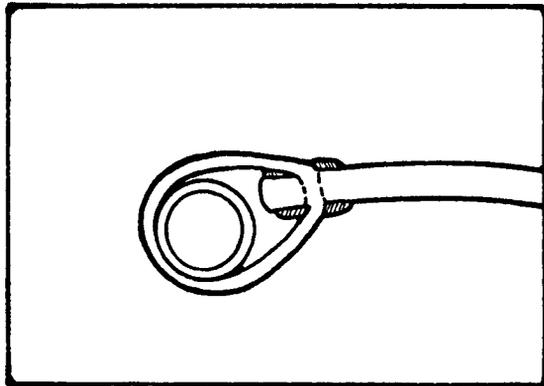

Figure 4.47. A plastic molded leading edge for Jim Jacobs's machine.

November 10, 1980

Dear Gary,

This letter mostly concerns the newest model, as we have tried to improve the design and efficiency as much as possible by increasing the airfoil characteristics and making the wind engine into part of an energy storage/utilization system. For this, we had a choice between generating electricity and compressing air. We have chosen the latter to experiment with.

About the sails — we have cut them slimmer to decrease solidity, and therefore increase rpm. The sails are held to the mast by rings of nylon (though we may go to steel), so they are able to rotate slightly about the mast. This allows them to take a better angle of attack, decreasing turbulence behind the mast pipe. Since the effects of sun and weathering on the nylon rings are unknown, we won't know for some time whether we will have to go with steel or not.

We have changed the elastic shock cords for Rubber

Rope®. It's a 1/16-inch diameter black cord made of EDPM rubber. We are pleased by this find. It has elongation in excess of 100 percent resting length, is essentially unaffected by sunlight (weathering) for 15+ years, has a 2,000-pounds breaking strength, etc. It is only 45 cents per foot, and comes in rolls so cords of any length can be made. Our company sells this material separately, and it has a million other uses, such as tie-downs for cars, etc. I even have a piece wrapped around my chimney, holding a metal cap in place. There are special hooks which are used with the system.

For guy cables, we have gone to 1/16-inch stainless steel, though we may switch to 1/32-inch if elongation, stretching under load, proves too great. We wanted the thinnest cable possible on account of wind resistance. Turnbuckles tension the whole assembly, with Loctite in the threads to keep them from coming undone. The cables are secured by the Nicopress (TM) system. This technique, well known in the field of sailing, involves pressing nickel-plated copper sleeves onto the cable with a special tool. The fasteners will hold past the breaking point of the cable, and because they have no sharp edges, etc., they pose no threat to the fabric sails. As you know, we run guys from mast-tip to mast-tip, which allows the use of light material, while attaining exceptional strength. The whole assembly is, in essence, a huge, tensioned truss.

The acrylic sails are doing nicely. We have discovered that our battens made of wood have broken in the middle. The stress was too great. We have gone to fiberglass, which appears to have solved the problem. Battens are, we feel, important, since they keep the sail from forming a pocket on the windward side, which greatly reduces the airfoil characteristic of the blade: the flatter blade with a gentle curve. Otherwise, the acrylic seems to be doing very nicely. Our initial fear

that the material might form a natural pocket from wind loading has proved unfounded. The sails return to their original shape when the sailing stops. On the other hand, that is only after six months, and we do not know what the effect will be after two or three years, or more. The manufacturer's guaranteed life is five years, and it may last two or three more in this application. We are making the sails in bright blue, though we can make other colors (red, yellow, green, etc.) but they are slightly more expensive. We will sell the set of three sail blades with grommets and edge-binding for about \$195 retail (blue), other colors about \$205.

The finest innovation, however, and one for which we are filing a patent, is a device I call the "Power-Tip" (Figure 4.48). I am pleased with the design and with the working results. It came about in response to something in one of the New Alchemy Journals. It was noted that the angle of attack had to be great (40 degrees) to start in low wind speeds, but needed to be flatter (maybe 10 degrees) while running, because the greater angle retarded the speed. Since I wanted the windmill to go at least 72 rpm in a 20-mph wind, while also starting in a 4-to-5-mph breeze, I reasoned that the tip should change its angle as the speed increased. I devised a simple system based on centrifugal force, which also increases as speed increases.

The triangular sail tips are attached to a pipe which slides over the mast at the outer end. A spiral groove is machined in the sail tip pipe, and a hardened steel roll pin is placed through the mast in the groove. It extends out of the mast on both sides, and through the groove. As the sailing assembly speeds up, the centrifugal force throws the sail tip out, but the pin in the groove forces the tip piece to rotate as it moves out. The faster the assembly goes, the more it throws the sail tip out. The tip begins at about 40 degrees downwind of the plane of rotation, but progressively flattens out as the



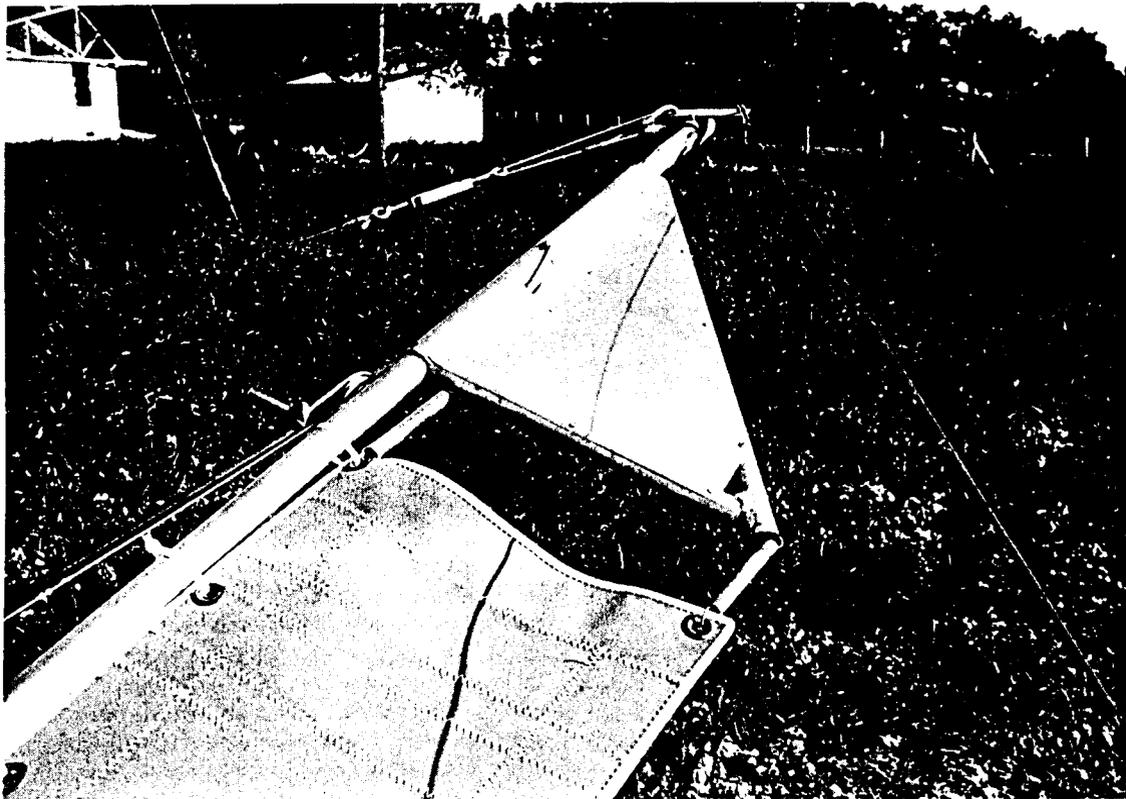

*Figure 4.48: The Power-Tip. The aluminum-skinned, triangular tip piece is shown clearly with the spiral groove and the fall pin in place. Springs at the top and*

speed increases. At about 72 rpm, the tip piece is in the plane of rotation, and if the mill speeds up further, the tip piece goes through the plane, and upwind of the plane. This places the tip piece and the outer end of the sail (which conforms to changes in curvature readily,

*bottom retain the Power-Tip, yet allow it to move outward when the centrifugal force is sufficiently strong. Also, note the Rubber Rope®.*

which makes the whole approach work) into a stall condition, whereupon it slows down slightly and then speeds up again. In effect, it is a governor, the speed of which is determined by the retaining springs attached to the sail. By attaching the springs to the sail, rather

than the mast, the sail is continually pulled tighter as the speed increases. The sail itself is retained by a cable from the central shaft.

Although we haven't experienced very high winds (over 40 mph) yet, I am confident the Power-Tip will work. I believe that low rpm and high torque are the way to go on simple, possibly home-built systems. This belief allows the use of lightweight, commonly available materials, and engineering/construction which doesn't need to be perfect. As long as the balance is very close, the mill will operate just fine for many years through a wide range of weather conditions.

The sail tips (Power-Tip) are covered with an aluminum skin to increase the power available, and the guy holders at the ends of the mast act as retainers, so that the tips can't come flying off, should the springs tear out of the sails, and the roll pin drop out.

As for what the second model does — it compresses air. We thought about pumping water, and we will offer a sailing model which will do just that, but we wanted a system which could store energy for later application by a family or small community. Because of the vagaries of the wind, one cannot depend upon it to be there when it is needed. We wanted to build a model which produces electricity, but decided to go with compressed air and pneumatic tools/motors to begin with. Our present water pumper, using a 2½-inch cylinder bilge pump produces about 350 gph (single acting) at 70 psi. I am not satisfied with the compressed air system yet. Efficiency appears to be very low and much more R&D is required. By using a series of hot water heaters for expansion tanks, we can go for about three windless days if we will do minimal conservation. But we can't do anything else with it, unless maybe through attachments to grind grain or saw wood, which we have not yet tried.

Our research, while we were trying to make up our

minds about air or electricity, led us to the marvelous Mr. Popp, who around 1880 had a huge compressed air system in Paris. There were over 10,000 subscribers and stations where 24,000-horsepower steam engines pumped air through miles of underground pipe, with remarkably little line loss. The lost heat (from compression) was put back just before use in the home by a gas flame, and the efficiency was a remarkable 70 percent for the entire system. Yet today, this highly sophisticated system which ran air motors and a host of tools, is rarely mentioned, even in books which ought to mention such things. We decided to follow Mr. Popp's footsteps, although on a somewhat less grand scale.

Our compressor puts out about 12 cfm (100 psi) at top speed (72 rpm). This is enough to run quite a few small air motors continuously, and with adequate storage, an air motor which develops 1¼ horsepower. The major expense in this system is for the series of storage tanks. Commercial tanks run \$600 to \$700 for 120 gallons of storage, plus freight. They, of course, will last a very long time, but the initial expense will be high. We are also investigating hot water heater tanks, and they look promising. A 55-gallon tank purchased for as little as \$100 new, is glass-lined (since there is water vapor in compressed air which causes corrosion), light, and readily available in many locations. Used tanks are somewhat more risky. Although new tanks are supposed to be tested to 300 psi, used tanks may have a weak spot. If people want to take a chance, and that's up to them, then the safest testing technique is to fill the tank with water, put a pressure gauge on it, plug all the openings, and attach an air compressor to it. Pump it up to 150 psi and leave it in the sun for the day. If there's a weak spot, it will show up, and with all the water inside, will not blow up, nor be very dangerous. However, a tank at 100 psi which ruptures and

only has air inside can be potentially quite lethal. We would recommend an earth bunker between storage tanks and the surrounding habitats.

An air motor operating at 40 psi and 15 cfm produces about  $\frac{1}{4}$  horsepower, which is enough to run a shallow well jet pump, so the system can pump water as well as do other useful work. We have even developed a low-cost concentrating collector to reheat the air before use to increase efficiency. And air tools are readily available, even from such giants as Sears (though I prefer some of the industrial brands better).

The only aspect of the system which we feel is unfortunate is the cost. The more we try to do, the more it seems to cost. It appears we will have to offer the compressed air model, ready to mount on top of a pole (tower), for about \$1,500, FOB Virginia Beach, Va. (while the water-pumping model, either in a pole or wooden tower mount style, will be about \$995 FOB, Virginia Beach, Va.). In addition, there is the cost of storage tanks, air hose, tools, motors, etc. and the buyer will have to erect a tower. All in all, a system price of \$4,000 is probably not unreasonable, though that seems too high to me. Still, by comparison with other complete energy systems, it may be considered moderate. The 40 percent tax credit (if the new administration doesn't dismantle it) will help sales considerably.

We had once talked about the best type of bearing for the entire sailing to rotate about, and I can now say that my assertion was correct. We placed  $3\frac{1}{2}$ -inch structural steel pipe inside 4-inch steel pipe, with a bronze thrust bearing between the pipes, and used a grease cup. It works like a charm, and is very low cost. The pipes cost only a couple of dollars (in quantity), though a machine shop will cut one for a little more. The  $3\frac{1}{2}$ -inch pipe is welded to the turntable assembly, and the 4-inch pipe is welded to the mounting bracket

which attaches to the top of the pole. While we used these sizes, larger pipe diameters can be found which "telescope," and that is what we use on the water-pumping model. The brass bushing (thrust bearing) can be fashioned out of a straight length of square stock, which is rolled to the correct diameter, and then brazed and filed. The grease cups (we use boat axle grease because it doesn't wash out easily) provide even greasing over an extended period of time. We use the same system on all the main bearings in the windmill housing too.

The tower we chose on account of its low cost and ease of erection. We used the penta treatment rather than the salt because of availability (though cost was the same), but stayed away from creosote because of chemical burns. The guy cables are  $\frac{1}{16}$ -inch, extra high (11,000 pounds) breaking strength, galvanized steel. We also sell that, by the way for 35 cents per foot plus shipping.

If you mention poles, be sure to mention the use of double pole steps on the uppermost three, as both feet need a place of rest while doing maintenance. We placed our steps every 16 inches, which we find quite comfortable. We started 10 feet from the ground to discourage passersby from taking a look around at 50 feet.

The tower is set between two smaller poles which are sunk 6 feet into the ground, and sticking up 5 feet. A  $1\frac{1}{4}$ -inch diameter steel pin runs through the three poles, and acts as a pivot or hinge for the main pole. The 50-foot tower weighs 1,900 pounds with the windmill (125 pounds) attached. We decided to first use a tractor to raise the tower, but, after having dropped the tower from 20 feet, decided to get a crane. It was a wise decision and not too costly (about \$140 on account of a 3-hour minimum). The erection went quickly and smoothly. We attached two guy cables

(first having figured out their approximate length), and with the crane holding the tower in place, we attached the third guy, and tightened the cables until the tower was as nearly straight up and down as possible. By the way, we ordered "extra-straight poles," and received some rather crooked ones. We weren't as particular as we should have been. If I were doing it again (and I hope to), I would send them back and get good ones. It doesn't hurt the tower to be slightly crooked, but it surely does look terrible.

The only sailing we feel comfortable with right now is the 20-foot-diameter model, but we do have a 30-footer on the drawing board, and have even talked about the problems we would likely encounter in a 40-footer. We will, no doubt, build them some day. First, though, we have to perfect what we have, sell a bunch, and then we will have the money to do more R&D. By the way, the firm, United Energy Works, can be reached through this address:

P.O. Box 1034  
Virginia Beach, Va. 23320

Yours,  
Jim Jacobs

*December 25, 1980 Christmas Day*

Dear Gary,

I have decided I cannot do everything I would like immediately, and I don't know the answers to many of the problems we face. Therefore, I will begin with the things which I *do* know.

1) I am impressed by the acrylic sails. They are strong and perform well. Even when they have come unhooked and flapped wildly, they have shown relatively little wear. Recently I let one go, unhooked, in

40+-mph winds for several days, to see what would happen. The outer end is now shredded but tomorrow we shall place a patch on the sail and re sew it. I believe it will be "good as new." I believe we can reasonably supply a set of three sails, as indicated in one of the previous letters, for \$195, including edge binding, grommets, and battens. I now believe that there should be battens in the outer tip as well as the inner base, and our sails will reflect this bias. Wood and fiberglass have proved too fragile or pliable. I hope to find a stiffer material which resists bending better. Also, a word of warning to those making their own sails. If the pockets for the battens are not made correctly, the battens will work themselves loose, and the action of the sailing will distribute the battens to parts unknown, or they will become dangerous flying knives.

2) I like the Rubber Rope (EDPM cord). Its response characteristics are superior to the braided, rubber shock cords and its life expectancy makes it a good buy. We plan to sell this material also.

3) I like, and feel very comfortable with, the lightweight, sailing assembly (mast assembly) itself. This consists of the three lightweight masts, the central shaft sleeve, the Power-Tip speed governors and the  $\frac{3}{32}$ -inch stainless steel cable guys. The whole unit can be shipped unassembled and put together with minimal skill in a couple of hours, with common hand tools. It is designed to fit onto a 1 $\frac{1}{4}$ -inch, cold-rolled steel shaft, provided there are at least 18 inches of free shaft extending for the central sleeve to slide onto. The whole assembly with sails attached weighs just 49 pounds. We expect to offer this for \$495, sails not included. It will be good for the person who designs and erects his/her own tower and power train. The 20-foot diameter sailing mast assembly is galvanized and painted white, except the stainless cables.

4) I am pleased by the erection technique using wooden poles for towers. We have done enough now

that I feel confident. The technique we use is to dig a hole (by hand, or machine if handy) some 5 or 6 feet deep, and then cover the bottom with 1 foot of stone or crushed gravel for drainage. Different regions of the country will have different drainage requirements. We have a crane with an 80-to-100-foot boom on it come out and hold the tower in place while we attach the 5/16-inch galvanized steel guy cables onto the anchors we have already placed into the ground. Assuming a 50-foot tower offers 50 square feet of resistance surface area, and the sailwing at 30 square feet (and those figures are liberal), that gives a total area of 80 square feet. At 50 pounds per square foot (100 mph), the load on the tower works out to 4,000 pounds of pull. We put in anchors with a safety factor of 2, or a rated holding capacity of 8,000 pounds each, though it is really the soil type which determines exactly which anchor is to be used. We do not anticipate selling the anchors or other hardware for erecting a pole tower. We only plan to offer the 5/16-inch extra-high strength, galvanized guy cable at 43 cents per foot, plus shipping.

5) We are currently selling and using a very simple, inexpensive, yet accurate wind speed anemometer/odometer. It measures average speed, current speed and total miles of wind. It's made of Lexan plastic, for marine environments, but the counter housing, which can be up to 500 feet from the anemometer cups, should be placed indoors. Power is either 110 volts AC or 12 Volts DC. It comes complete with indoor measuring units, AC adapter, cup assembly with 12-inch PVC mast, mounting screws and 60 feet of wire. It sells for \$109.95. . . .

. . . Some last, little notes. We have found the Lubesite® grease dispensers to be a poor choice. We were attracted because they are refillable and very attractive (at least my wife thinks so). But we have found that they dispense the grease too quickly for this remote application, though possibly the manufacturer

can supply a different spring. We have not contacted them. Instead, we are trying another brand which uses a gas to push the grease out. The grease cups come in a variety of sizes, according to how long it takes to completely dispense the grease. We are presently using the two-year variety, though that may prove to be an inadequate amount of grease. Time will tell.

Grease also plays an important part in the solution to another (perceived) problem. The original method of attaching the sailwing mast assembly to the main shaft on the NAI Sailwing was the bolting together of two matching plates. I had wanted to go with a sleeve to avoid the precision machining necessary to have the main shaft and the mast shaft line up perfectly. Without precise alignment, there would be a wobble, which would have wearing consequences on the bearings. The sleeve, while eliminating this problem, is not without some of its own. The first, as you know, was how to get the mast assembly high enough and out far enough so that it would slide onto the main shaft. We solved this by the use of an assembly above the main power train which slides in and out with a series of pulleys attached to it. The mast assembly is hoisted from the ground by means of a boat winch at the tower base. However, even though the main shaft is lightly greased, when the sleeve slides over the shaft, some of the grease is rubbed off. Metal-to-metal contact in a weathering environment produces rust, which may ultimately weld the sleeve and the main shaft together. This negates the advantage of very speedy removal of the mast assembly. We have placed grease fittings on the sleeve, but will not know for some time if this will effect a solution — or even if we had a problem in the first place. If nothing else, it does underscore our commitment to details.

Yours,

Jim Jacobs

January 15, 1981

J. Baldwin comments:

The Power-Tip seems to be a good idea. I'm a little worried about galvanic corrosion. Cutting the spiral groove isn't especially do-it-yourself, and it might be nice to get the same result some other way that can be done without that special cut or welding aluminum.

The nylon ties will not last worth a damn, though there are black ones available that should last longer. Sunfish and Hobie use a special tie doodad that is made just for that purpose, though it is possible that they don't last either, since it is expected that the sail will be removed when the boat isn't in use. The nylons also get brittle in the cold, and fail by cracking, which you can be sure will occur at the worst time of maximum stress.

I like the assymetric use of telephone poles and that would be the way I'd go. However, wood towers of dressed lumber are not all that much cheaper than steel.

*Steel towers should have ground rods that go around the concrete, and it is best to have one on each leg!!!* Otherwise a lightning strike can blow off the concrete from the legs at a bad time.

Cables should not be smaller than  $\frac{1}{8}$ -inch even if they are stainless and even if they are rated high. Small cables fail a lot easier than fat ones from abrasion, small damage, age, and fatigue. Yes there is wind resistance, but the machine is a drag machine anyway, and I doubt if it makes much difference. I've seen too many  $\frac{1}{2}$ -inch mast stays break on small sailboats.

January 16, 1981

Joe Seale comments:

Using a cam follower and rocker arm at the tower top to reduce side-to-side shaft motion and permit use

of a cheaper pintle bearing (to replace the expensive turntable now in use) may be a good idea — I'd want to see how well that assembly lasts, i.e., how well designed it is.

Designing around telephone pole towers sounds like an excellent idea, one other small wind system manufacturers are taking to.

A sail rotor with pipe mast and single-surface sheet stretched out behind cannot achieve a very high lift-to-drag ratio, and this means that operation at high tip-speed ratios cannot be efficient, no matter what the solidity ratio of the sails is. Narrowing the sail width further will not raise the optimum tipspeed ratio above 3 to 1, but will only reduce both starting and running performance.

The Power-Tip idea works well to provide high starting torque and moderately high-speed operation with speed governing. But beware of very high winds causing extreme bending and torsion forces at the mast tips. The design places the tip area of the sail straight across high winds at a right angle, a high-force situation. Alternatively, depending on how the springs at the sail tip give way, the sail tip might pitch back enough in extreme winds to let the rotor run away at maximum tipspeed ratio, with disastrous consequences. Properly scaled wind tunnel tests and/or approximate force calculations are needed to avoid serious failures in 60-mph winds.

Despite the success of Mr. Popp's compressed air utility, you can't buy efficient small air motors today. They are all designed for convenience and portability. If they were much more efficient at extracting energy from expanding air, they would chill the air excessively from energy extraction, causing them to ice up. By using gas flame reheating at the user end, Mr. Popp avoided that freezing problem and was able to use an efficient motor. I have calculated maximum overall

system efficiencies of about 10 percent using available small-scale compressors and air motors. The few figures in Jim Jacobs's letter lend doubt that he is doing much better.

I am very dubious about using water heaters, even brand new, for compressed air storage. It is true that a test with high pressure water is not dangerous, since water is so incompressible that it stores negligible energy when compressed. But compressed air tanks are

certified by checking whether their volume changes inelastically (i.e., they don't come back to precisely the same volume) upon full pressurization. That test reveals whether any materials are starting to yield. Compressed air is extremely dangerous, and I would not settle for any compromises in its containment. That, of course, implies expensive containment, a major reason that NAI has never gone to a compressed air energy system.

# The Nuts and Bolts of a Water–Pumping Windmill System

IN THIS CHAPTER, WE WILL EXPLORE THE NUTS AND BOLTS OF INSTALLING, erecting, and maintaining your water-pumping windmill system. With the exception of Section 3 (Maintenance), the information in this chapter applies to both the Sailwing and commercial windmills.

When it comes time to install and erect your WPWS, good planning can save time, money, and extra trips to the hardware store. The well should be built first, and the water tested right away. Then you can assemble the basic tools needed for the job. These include lots of heavy rope, some pulleys and chain, hammers, wrenches, vice grips, drift punches, screwdrivers, shovels (maybe a crowbar), pipe wrenches and pipe dope (affectionately known as turkey shit at our plumbing supply shop), a plumb bob, and a good tape measure. A transit will help for leveling the tower although a long level can do the trick. You will want to have a lot of friends around, so stock up on beer and other essentials. (For best results, distribute the beer after the job is done). And for goodness sake, be sure to bring along a good sense of humor—this tool may be the most useful of all.

I can't emphasize enough the good sense of planning the whole job through in painstaking detail *before* you begin. Order *all* parts before you've started and give yourself plenty of lead



time for shipping delays, parts back-orders, and so forth. Ordering windmill supplies is not like running down to the automotive supply shop. Windmill and pump suppliers do not tend to run booming, high-volume businesses, and even the best-prepared supplier may take weeks to find a certain component. And while windmill companies can direct you to their dealer in your area, you may find better deals on pump supplies at your local plumbing shop. Inevitably, your plumbing supply shop will have at least one old timer who remembers the day when "we were putting windmills up all over the place." Such a fellow may be a treasured and valuable ally in the effort ahead.

In case you don't have this sort of local resource, I've included a list of pump and water systems suppliers in the appendix.

I prefer to erect my windmill and tower first, and install my drop pipe, pump, and pump assembly after that. The tower is useful for hoisting and lowering the pipe and pump rod. However, what you do first is largely a matter of personal preference, and factors like waiting two weeks for delivery of the tower may help you to map out your own agenda. Here, we begin with installing the pump assembly, and then move on to erecting the windmill. Finally, we'll discuss some hints about maintaining your machine.

## **INSTALLING THE PUMP SYSTEM**

Your well is installed; your water is tested; what next?

First, a precaution. Working around a water well requires care and concentration. Be alert to potential pollutants which might spill into the well, and keep away any objects which might fall in. Retrieving tools or objects from a well is not impossible, but can be frustrating and time-consuming. The best advice is to keep the well capped until you are absolutely ready to begin lowering the pump cylinder and drop pipe. Don't let children play near your well, or you'll be sure to find rocks down it in no time.

Once the well is cased and the water is tested, you should have it "developed." Developing a well involves using an electric or gas-powered pump to pump it out at several hundred gallons per hour, for several hours. This pumping causes the sediments around the well point to settle and compact, thus lessening resistance to water flow over the well's lifetime. Your well driller can do the job for a few extra dollars, and he or she can test your drawdown (see Chapter 2) at the same time.

Once the well has been developed, the fun of putting in the cylinder and drop pipe begins. Invite a few friends — this is definitely not a one-person job.

You can either build your tower now or else build a temporary platform for raising your drop pipe sections vertically before they go down the well.

First, connect the pump cylinder and screen

(*never, never, never* put a wrench directly on the cylinder — grab it at the coupling) and screw in the bottom section of drop pipe. Apply pipe dope liberally to the threads; it pays over the long run.

Now you are ready to begin lowering the pump and drop pipe into the well. If you have an open-top pump cylinder, you will put the cylinder and drop pipe in first, followed by the check valve, plunger, and pump rod. With a closed-top cylinder, you must put in the pump, check valve, plunger, drop pipe, and pump rod all at once. The procedure described here is for an open-top cylinder system.

Lowering the drop pipe is both exhilarating and nerve-racking. It takes a lot of patience. And if you are unfortunate enough to drop a section down the well, you will be sidetracked into an auxiliary fishing excursion which, at this juncture, is no fun at all. Tie your tools to your belt, and keep all possible contaminants away from your well casing. One easy way to lower the drop pipe is by grabbing it at an angled bite with a pair of pipe wrenches (Figure 5.1). You can also use a pipe holder, or a pipe clevis. These hints take on added significance with each added pound of pipe that you lower into the well. You will want several sets of hands holding the pipe, and another pair or two tightening on successive sections. *One* person should give instructions and everyone else should heed only that person's commands. If the well is deeper than 75 to 100 feet, don't even

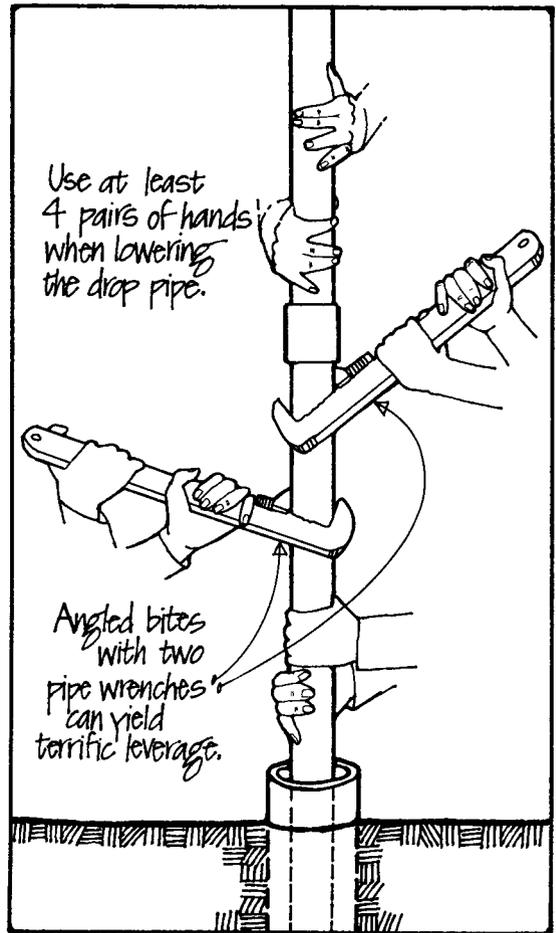

*Figure 5.1. Lowering the drop pipe. Use at least four sets of hands when lowering. Angled bites with two pipe wrenches can yield terrific leverage.*

attempt to lower the pipe without a good pulley system. One device that's nice for deep wells is the pipe holder shown in Figure 5.2.

Attach each pipe section with great care so you don't have to pull it all back up again. Once you've reached the desired depth, fasten a tee at the top and rest the whole assembly on the lip of the well casing. You can determine the correct depth of submergence by suspending a plumb bob and marking the water line. A typical installation will have at least one 10-foot pipe section below the water table as insurance against drawdown. If you are coupling an electric submersible pump into the system, then be sure to have the well experts calculate your well's replenishment rate (drawdown) for different depths.

Let's assume you are choosing a packer head instead of a standpipe. The next step is seating your bottom check valve and connecting your pump rod.

Seating the bottom check valve is as simple as dropping it down the drop pipe (literally), as long as you drop it right side up (Figure 5.3). Make sure the threaded side is up and the valve is cleared of cotton or paper ball protectors. The threads are useful when leather replacement becomes necessary, as we'll discuss in the section on maintenance. Drop the valve down the pipe, and listen for the splash. After about an hour, the leathers will swell and the valve will conform to the cylinder wall.

A fun exercise at this point is to use a mirror to see the water in the well (Figure 5.4). Face the mirror toward the sun and angle it downward until the reflection strikes the water. This technique is also useful for "fishing out" objects which have accidentally fallen in.

Now you are ready to attach and install the plunger and pump rod. Tighten the plunger to the rod, being sure to avoid grabbing the leathers with your wrench (Figure 5.5). Add a few dabs of silicon grease to the leathers for ease of installation.

Installing the pump rod involves essentially the same precautions as installing the drop pipe. Begin by connecting a manageable length of rod above ground. Be sure to tighten the sections down to the last threads, but be careful not to bend the rod in the process (Figure 5.6). Then, using as many hands and warm bodies as are available, proceed to lower each section into the drop pipe, slowly and carefully. Sometimes, it helps to station one person above you on the first tower section (if the tower is built) or on an elevated platform (Figure 5.7). This technique enables you to manage a long section of pump rod more easily. Attach each successive section as tightly as the threads permit, and lower away. Connect successive sections of rod with great care, holding on to the sections that are in the well, and then lowering until you can connect the next.

You must connect your polished rod before the

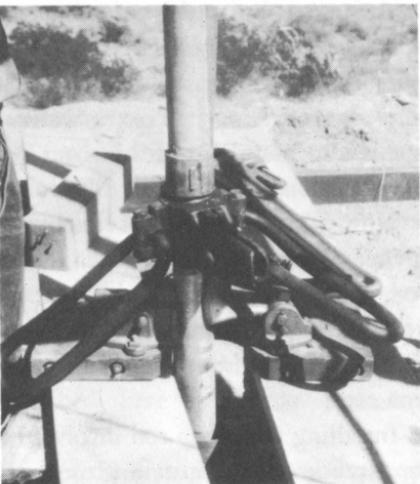

*Figure 5.2. A pipe clevis.*

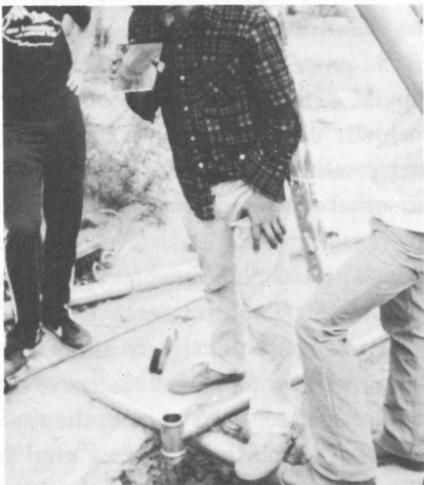

*5.4. Using a mirror to peer down a well.*



*Figure 5.3. Seating the bottom check valve in an open top cylinder. Make certain that paper or cardboard protectors are removed from the ball valve.*



*Figure 5.5. Attaching the plunger to the pump rod.*



*Figure 5.6. When attaching sections of pump rod, be sure to avoid bending the rod.*



*Figure 5.7. Station an elevated person above the well when lowering the pump rod.*

plunger enters the cylinder at the bottom of the drop pipe. Needless to say, you do not ever want the plunger to move out of the cylinder at any point during the windmill's stroke. The polished rod, you remember from Chapter 2, unlike the steel pump rod, is designed to operate in both the air (above the packer head) and the water (below the packer head in the top of the drop pipe). Thus, the polished rod should be attached at that point in the pump rod assembly where the windmill stroke keeps the plunger inside the cylinder, but so that the pump rod never emerges through the packer head (Figure 5.8).

Once the polished rod is attached, you can lower the rod until it reaches the bottom of the cylinder. The plunger is now sitting on the check valve, where it can stay until you connect the pump rod assembly to the windmill and red rod above. Now it is time to install the packer head, sometimes referred to as the stuffing box.

Every packer head on the market (see Appendix) has its own particular procedures for installation. I prefer the Jensen Brothers' "Automatic" Stuffing Box. It is not the least expensive packer, but it is a simple, easy-to-install device that in my experience performs flawlessly. The Jensen Brothers' Packer Head comes with its own polished rod and brass sleeve assembly, which is adjustable for different heights (see Figure 2.11, Chapter 2).

Once the packer head is installed and tightened on to the top of the drop pipe, you should have

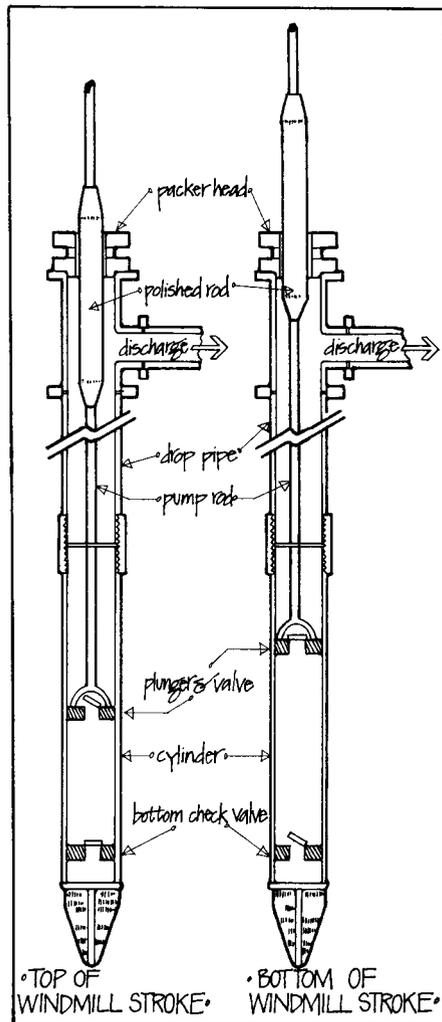
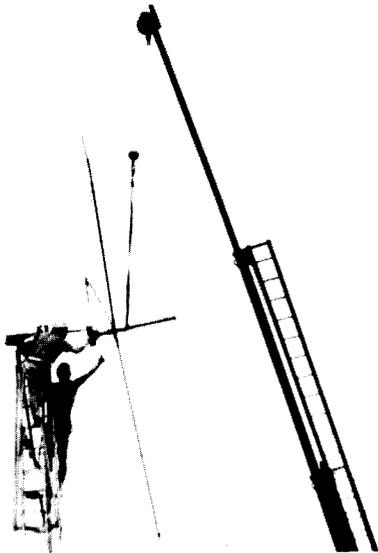

Figure 5.8. The polished rod operates in the air and in the water within the drop pipe.

enough pump rod sticking above ground for connection to the windmill red rod. It is now time to move on to erecting your windmill and windmill tower.

## ERECTING THE TOWER AND RAISING THE WINDMILL

There are many different schools of thought on how to proceed with this task. Some like to build the tower piece by piece and then raise the mill by gin pole or crane (Figure 5.9). Others prefer to



*Figure 5.9. Hoisting the rotor by crane onto a completed, standing tower.*

Robert Sardinsky

build the tower on its side, and raise it all at once by crane or other such power source (Figure 5.10). Yet others favor installing the windmill on the tower, while it lays on the ground, and raising

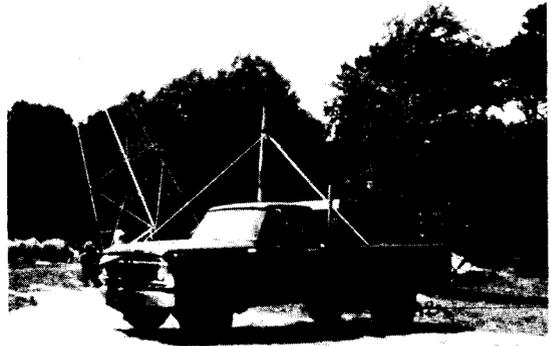

*Figure 5.10. Hoisting the prebuilt tower.*

mill and tower all at once (Figure 5.11). The economics of each of these three options will depend largely on what kind of equipment (cranes, trucks, winches, pulleys, and so forth) is available.

For those without access to a crane or winch truck, the "piece by piece" method may be most appropriate. On the other hand, this procedure is labor-intensive, and more hazardous, and if you are paying for your labor, the \$40-per-hour crane may look better in the long run.

My advice is to price out all the rental options first. Don't forget the hourly rate for getting the



*Figure 5.11. Hoisting the windmill and tower at the same time.*

crane to and from your site. Next, determine whether you can plan your major lifting activities for a single day, or two successive days. You will probably find that having a group of friends over for the tower erection or mill raising is the cheapest strategy. Make a social event out of it! And remember to stock up on food and beer and a good time is almost guaranteed — provided that you are prepared.

#### ERECTING THE TOWER

Each tower company supplies its own directions for erecting the tower. Be sure to wear a safety belt and a hard hat at all times. Tie your

tools to your belt with enough rope to permit convenient handling. One other hint— a Vicegrip® and a drift punch may be the best friends you could bring along for tower building. Use the drift punch to align the holes where several pieces of the tower intersect. Once the holes are aligned, clamp down on the tower pieces with the Vice-



*Figure 5.12. Insert a drift punch, align the holes, and clamp with a pair of vice grips. Then remove drift punch and insert bolt into aligned hole.*



grip® and withdraw the drift punch to insert the bolt (Figure 5.12).

There is no one preferred method of tower lifting to recommend, although Figures 5.9 through 5.11 suggest a number of different methods. One important hint for this job is to tie several guy lines to either side of the tower, and keep them taut in a line perpendicular to the lifting direction. This way you will avoid the disaster of a sideways fall during the erection procedure. There should also be a guy wire on the opposite side of the lifting device to prevent the tower from going too far "up and over."

Once the tower is vertical and in the footing holes, the following basic procedure should be followed: The windmill tower must be absolutely level, and plumb over the well. Otherwise, one or more parts will certainly be damaged in short order. If the tower is not level, uneven stress can cause a wobble in the wheel, or rotor bearing deterioration. A tower that is not precisely over the well will cause bent pump rods, rapid wear on the pump leathers, and increased stresses on the windmill transmission.

To plumb the tower, tie your plumb bob to a point in the precise center of your tower top. The cord should reach a point just above your well. Make darn sure that your knots are good and that your string is sound, or you'll be fishing a plumb bob out of your well before you are through.

Shimming and adjusting to level and plumb

takes some time and a good deal of patience. You will need at least two people — one at the base with a shovel to shift the tower feet, and the other above with a transit or level, and a plumb bob. A transit, if available, is the best tool for this task and assures you of a precise job. Otherwise, a long 4-foot level is acceptable.

After you have set up and levelled your transit, select one tower leg that will be the baseline for your transit marker. Now, proceed from leg to leg, moving the earth around under the feet until all four legs are exactly level with each other. Keep an eye on your plumb bob, and be sure it is precisely over the well when you are through levelling. Recheck each leg at least one or two times until you are certain that the tower is level and plumb. Don't cut corners here, or you will pay in the long run. Once the tower footings are poured, you will have a hard time readjusting for small errors.

Once you are absolutely certain that the tower is level and plumb, you are ready to pour concrete. There is no such thing as too much steel in your tower footings — the more reinforcement bar, the better! One friend tells me that he has seen tower footings shatter when a lightning bolt struck the tower above. Wrapping the footing in wire screen will help avoid disintegration of the concrete under such conditions. Attaching ground rods to each leg is an even better solution.

Once the reinforcement bar is in place, begin

pouring by placing a few shovelsful of wet concrete on each foot of the tower. This prevents the tower from leaning out of level due to excess pressure on one leg. Once the first shovelsful are in, recheck your plumb and your level. When you are sure the tower is still true, continue pouring the concrete by filling each hole up to the one-third or one-half mark. Then, check again to be sure the tower is plumb and level, and finish pouring the concrete to ground level. Recheck the tower one more time, and make this final check good. It will be your last chance to make adjustments.

Follow your good sense and local experts' advice on curing the footings. Once the footings have dried and cured, you can erect your windmill. Again, a number of options are available, but the best advice is to first think the whole matter through.

One other option for erecting the tower deserves mention. In areas where hurricanes or other such phenomena are common, it is advisable to erect your tower so that it can be lowered or raised on a hinge as in Figure 5.13. Although you need to consult your tower manufacturer or a structural engineer before proceeding with this option, it can be a saving feature in the long run. A friend of mine in Florida lost two windmills to hurricanes before he smartened up and built his tower this way. Now whenever a storm is approaching, he lowers his 30-foot tower and windmill using his truck winch, and stands it back

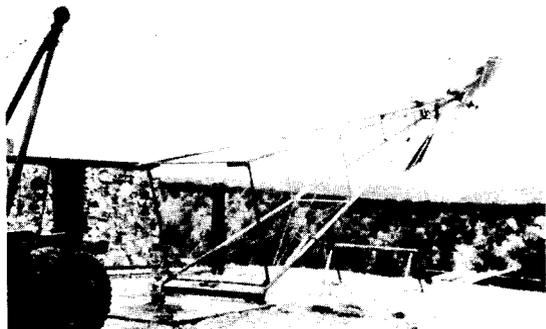

M.I. Rasmussen

*Figure 5.13. A "binged" windmill tower.*

up after the storm has passed. A tower gin pole (Figure 5.14) is necessary for this job.

#### RAISING THE WINDMILL

In placing your windmill on the tower, nothing beats a crane for ease and convenience, but sometimes cost and equipment availability mandate homespun strategies. A gin pole with human or machine power is a ready substitute. Again, use common sense and prudent judgement in selecting your materials. A 2-inch galvanized pipe makes a gin pole that will support the New Alchemy Sailwing or a commercial 10-foot diameter windmill. For bigger windmills, use a 3-inch pipe for the gin pole. Raising the gin pole and attaching it firmly to the tower takes many hands. The gin pole must be long enough to allow ample surface area for chaining it to the tower, and should also extend high enough above the tower

to enable lowering the mill into the exact center of the tower top. Figure 5.15 shows a gin pole of the proper length.

Use the heaviest chains available for attaching the gin pole to the tower. Hook the chain to the lower end of the pole so it is held from falling vertically, and then wrap the remaining chain around the tower leg and the gin pole until the pole is snug against the tower. Be sure to block it at an angle so that the gin pole top is directly over the center of the tower top, but also so that it will not obstruct the wind machine as it is lowered into the top fittings. Attach the pulley or block and tackle, and thread the lifting rope through before

you stand the gin pole up, or you are liable to be shinnying up some time later.

I recommend hoisting the mill in two sections — first the turntable and crank, followed by the rotor — to avoid damaging the sometimes unwieldy rotor assembly. Most commercial machine rotors can be assembled on top of the tower with little difficulty. Manufacturers' directions for this job are usually straightforward. The New Alchemy Sailing rotor can be built on the ground and slipped over the main rotor shaft once the turntable has been installed. The procedure is simple and convenient, and well-suited for gin pole work.

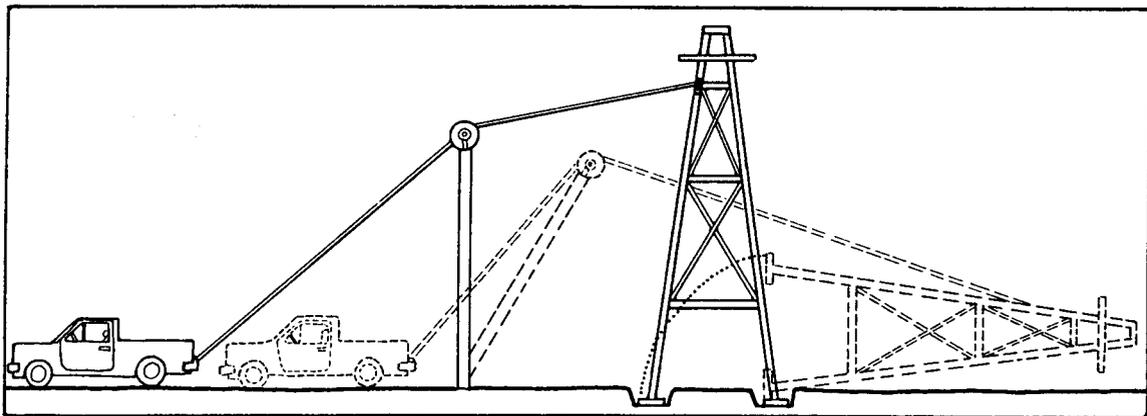

*Figure 5.14. Using a tower gin pole. A tower gin pole is useful for lifting towers with a pickup truck or tractor. Be sure to use plenty of guy cables in all directions.*



*Figure 5.15. A gin pole in place on the tower.*

When lifting the rotor, use a sturdy rope and tie your very best knots, being careful (1) not to have any rope cross the part of the turntable that sits in the tower fitting, and (2) to tie the turntable so that it will hang vertically when suspended off the ground. A tilting turntable will make the topside person's job more difficult when it is time to slip it into place.

You will also want to attach at least one "tail-rope" to keep the turntable away from the tower on the way up. Wrap a loop around a tree for added leverage.

The actual raising can be performed either by hand or by using a truck or tractor. You will want to pull downward to the extent that this is possible without getting your crew directly under the hovering turntable above. Sideways stress on the gin pole will cause it to bend away from the tower center and could be troublesome. A second block or pulley chained to the bottom of the tower (Figure 5.16) will enable your crew to apply vertical tension without endangering themselves.

One person topside should be all that is required to guide the machine into its fittings. This person should direct the raising operation. Following the topside person's commands, raise the turntable slowly, while the guy line people keep tension on their rope. When the turntable is over the tower top, the topside person will feed it in, all the while directing the ground crew to raise or lower when appropriate. Once the turntable is in place and firmly attached, the rotor (Sailwing) or rotor sections (commercial mills) can be raised for assembly. For commercial mills, follow the manufacturer's directions exactly when assembling the rotor. Carelessness will result in a wobble and damage to the bearings.

By the way, blades or blade sections must be equal weight to insure a balanced rotor. It is sometimes useful to weigh each of the blade sections before raising them. On at least one occasion, I have had to compensate for factory errors by trimming excess off a heavy rotor section.

Once the rotor is assembled, take your gin pole down and give the rotor a few spins. It should spin freely and noiselessly. Inspect it carefully. Remember, if your windmill is to be economically justified, it will have to produce useful work for many years to come. Do things right the first time and you'll be assured of many years of performance.

This is the time to fill the commercial mill's crankcase with the requisite volume of oil. In the case of the Sailwing, grease each bearing with a

few squirts at the nipples. Use a molybdenum grease. Now you can turn to the pump rod, and link the windmill with the pump.

The first step is to spin the rotor so that it sits at the bottom of its stroke. Follow the manufacturer's instructions or the Sailwing guidelines (Chapter 4) for attaching successive sections of pump rod and red rod, the swivel, and pump rod guides. Cut the red rod until you are within a few inches of the polished rod where it emerges from the packer head. Now, a very important point:

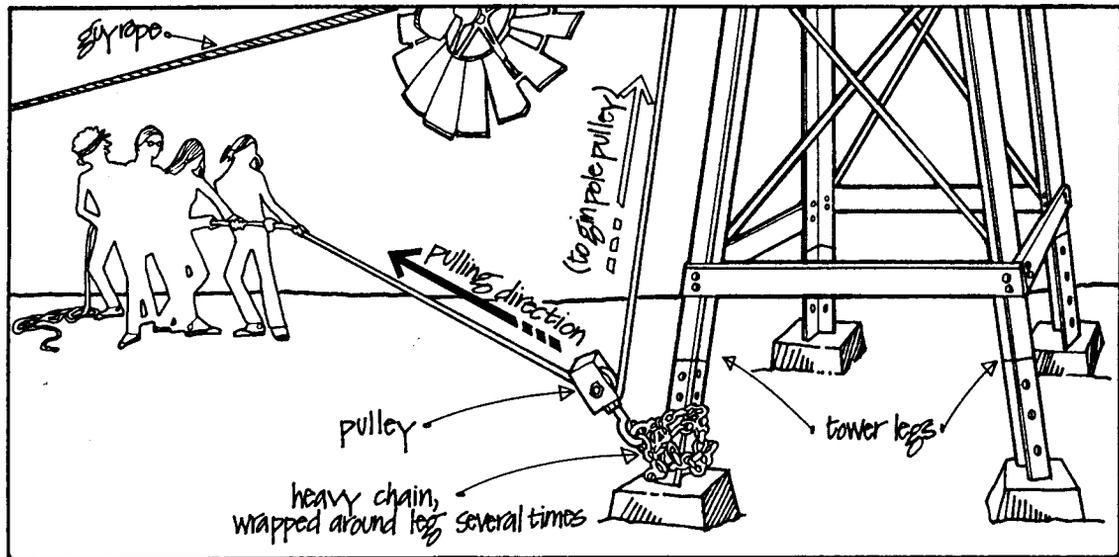

Figure 5.16. Hoisting a windmill on a prebuilt tower. Use a pulley chained to the tower base, for safety's sake.

*Making sure that the pump rod is at the bottom of its stroke, pull the polished rod up 2 or 3 inches for connection to the suspended red rod attachment point. This step ensures that the plunger is never compressed against the bottom check valve, which would result in damage.*

You are now nearly ready to pump. Give the rotor a few turns. If water doesn't emerge in a few minutes, recheck the pump system for any problems. Don't forget that new plunger leathers take a good hour to swell up before they will create a suction in the cylinder.

## MAINTAINING YOUR WINDMILL

Maintaining your wind machine can be a simple, even enjoyable labor, especially if you've done everything correctly up to this point. Barring any unusual conditions (such as hurricanes!) your commercial windmill should require only a crankcase cleanout and oil replacement every year, and replacement of pump leathers about every three years.

Windmill gear oil is 10-weight, nondetergent lubricant. Don't cheat here — additives in other mixes may cause deterioration of your cast crankcase. A magnetic drain plug will be useful during the annual oil change, for thoroughly cleaning out the crankcase. And if you really want to get it clean, Kerosene is a sure-fire cleanser.

Replacing pump leathers is a simple, inexpensive procedure. If you have a closed-top cylinder,

you will have to pull the entire drop pipe (and water column), simply by reversing the steps in the installation. However, before you replace the assembly, inspect the inside of the cylinder for scores or grooves caused by sand particles. If the scores are deep, you may need to replace your pump. In some cases you will note an uneven, oval wear in the cylinder, due to a bent pump rod or a drop pipe which is not truly vertical. This situation can be remedied by cutting 6 inches from the pump rod, thus allowing the plunger to work in a new, smooth, untouched part of the pump cylinder. This remedy is possible only if the pump cylinder is long; otherwise you will have to buy a new cylinder. Also inspect the screen for corrosion and replace it if needed. When you replace the rod and drop pipe, try to find the bends and use a level to be sure the drop pipe is hung vertically. Don't forget to again apply pipe dope liberally to all the threads.

When replacing the pump leathers in the case of an open-top cylinder, begin by disconnecting the polished rod from the red rod. Remove the packer head. Now, if you remember, the plunger has a male thread, and the lower check valve has a female thread. Connect the plunger to the lower check valve, by carefully setting the pump rod and plunger down on the check valve, and gently rotating the plunger in a clockwise direction until you think both are engaged. Lift the polished rod up. You will know the check valve is connected if

you feel a distinctive resistance followed by a sudden release, like pulling a bathtub plug, and hear a "whoosh" sound as the water column suddenly discharges down past the now disengaged bottom check valve. Pull the plunger to the surface, removing successive rod sections as you go. Replace the leathers, and reinstall the components as you did the first time.

### THE NEW ALCHEMY SAILWING

In the case of the New Alchemy Sailwing windmill, maintenance is a bit more involved and requires attention to a number of details.

#### *Sails*

*Sails must not flap.* Their lives will be greatly extended by (1) keeping them taut, and (2) not allowing them to make contact with any bolts, clamps, or other parts.

Sails should be furled either nightly or when storm winds are anticipated. The Sailwing is not designed to sustain greater than 30 to 35 mph winds over extended periods. Furling the sails in these situations will extend the lifespan of both sails and guy cables.

To furl the sails, bring the mill to a stop. Unclip the long shock cord from the adjacent mast and, making sure not to let the sail flap against the mast hardware, slowly wrap the sail around the mast, pulling it smooth and taut. When the sail is wrapped, pull the cord around it, winding it so

that it holds the sail to the mast, and clip the cord to anything convenient. Move to the next mast and repeat, until all three sails are furled. The rotor can then be allowed to spin freely. A rotor with only the tip sailcloth exposed will not develop unsafe amounts of torque.

#### *Guy wires*

Cable clamps, eyebolts, and turnbuckles should be inspected and tightened regularly, particularly after high wind periods. **Check cables for possible fraying or wear.** If the cables show any signs of wear, **replace them immediately.** **Never let the mill turn unless all guy wires are taut and secure.**

#### *The bearings*

The Rotek turntable and flange bearings should get an annual squirt or two of fresh grease. Nipples are easily accessible for this two-minute job. There should be no other maintenance needed, since this part of the machine is built to last. Keep your fingers away from the bearings and crank. There is roughly 2,000 pounds of force working here in moderate winds, and it will break a finger with no problem.

#### "FISHING DOWN THE WELL"

Don't laugh. You will drop one thing or another down your well at least once in your lifetime. Such a mishap can be real trouble if the object is small and without edges to grasp. The

typical accident will involve either a plumb bob, a drop pipe section (ugh!), a section of pump rod, or (no kidding) a beer can. I hate to sound like a doomsday planner, but, should the inevitable drop down the well involve a plumb bob, I like to use one that will be easy to retrieve. For retrieving a plumb bob or a beer can, you can fashion devices

with hooks, wire claws, prongs, and other delightful shapes to snarl or grab your object. It takes real finesse (and lots of patience) to retrieve a drop pipe or pump rod. The only real way is to use another section with the opposite thread. The mirror trick mentioned earlier in this chapter will be of some help, as will a flashlight.



# The Economics of Water-Pumping Windmills

MAKING ECONOMIC COMPARISONS BETWEEN DIFFERENT TYPES OF WINDMILLS is a tricky business. Each windmill possesses its own peculiar traits and maintenance requirements, and each site or application poses a specific set of criteria with which to contend. The Sailwing develops high torque in low winds, but requires manual furling in high winds. A commercial windmill's pumping capacity, and its payback period, can be drastically affected by changing the cylinder size or by altering the demand for water volume and pumping rate. These sorts of factors defy simple economic comparisons.

Comparing a windmill with a conventional diesel or electric pump is even more difficult. You must be willing to engage in a life cycle analysis over a period of ten years or more. Factors such as projected maintenance requirements, type of fuel, inflation of fuel prices, and anticipated lifespan of the pump, added to the already-complex site and water usage criteria, pose a most difficult situation for analysis.

Electric pumps generally give desired pressure and flow on demand. Water-pumping windmills work only in windy periods, and require costly storage systems to get through windless periods. On the other hand, concerted water conservation efforts and altered use patterns can obviate the need for "on-demand" water twenty-four hours per day. Electric pumps are known to

fail in fires, while windmills remain unaffected. Then there are the long-term environmental consequences of relying on fossil fuels. These are among the many complex factors which make cost comparisons difficult.

Nevertheless, there are trends that we can draw from to make at least crude predictions of economic payback. Conventionally powered pumps have generally predictable performance records, as do commercial windmills. The New Alchemy Sailwing does not have a performance history from which to make such judgments, but a rough analysis is possible.

In this chapter, we will briefly compare the Sailwing windmill with a commercial machine. We will then analyze the economics of commercial windmills versus conventional pumps. Finally, we'll perform cost analyses of the two case studies we discussed in Chapter 3.

## THE SAILWING VERSUS COMMERCIAL MILLS

By now, you should have a good feel for the differences between the New Alchemy Sailwing windmill and commercial wind machines. We briefly compared the two at the beginning of Chapter 4. The Sailwing owner will have a machine that:

- requires less startup capital costs than a commercial windmill
- can be built almost exclusively from locally

available, off-the-shelf parts

- requires complete fabrication of components and access to welding skills and equipment
- requires maintenance and monitoring in anticipation of high winds
- requires manual furling from a position on the tower
- requires replacement of sails every four to five years, depending on the seasonal use and care of sail cloth
- is a new design, and thus has a lifespan that is difficult to estimate.

The commercial windmill owner's machine:

- is more costly than a Sailwing windmill
- can be purchased completely from the dealer's catalogs
- needs only be assembled at the site — no welding or fabrication is required
- has an automatic turnout mechanism for high winds
- can be furled from the ground
- comes with a one- to five-year guarantee (depending on the company)
- has a long anticipated lifespan, averaging thirty to forty years.

In terms of actual startup costs, we'll compare windmills that are assembled and ready to be hoisted on to the tower. A new, 20-foot-diameter

Sailwing windmill costs \$875 in materials and takes roughly twenty-five person-hours to fabricate and assemble, including five hours of a good welder's time. This windmill operates at roughly one-third the rotor efficiency per swept area of a commercial, metal, multibladed wind rotor. This means that a 20-foot-diameter Sailwing compares most readily to a 14-foot-diameter commercial mill in terms of expected power output for a given wind. Pumping performance data for both machines substantiate this comparison. In January, 1981, a 14-foot Dempster windmill (without shipping) cost \$4,860, and a new Aermotor cost \$5,430. The Heller-Aller Company, manufacturer of Baker windmills, does not make a 14-foot windmill. Their 12-foot mill lists for \$2,414, compared to \$3,390 for a Dempster 12-footer, and \$3,357 for an Aermotor of the same size. Each of these mills takes approximately six person-hours to assemble for hoisting (including assembly of the rotor).

### **WINDMILLS VERSUS CONVENTIONALLY FUELED PUMPS**

A number of analyses between windmills and diesel, gasoline, or electric pumps have been conducted in the last ten years. Each is appropriate to a particular site and geographical area, but taken together they give some indications for making similar judgments about a home or small farm system.

Steve Blake, from the Appropriate Technology Group in Kansas, prepared one such analysis for The World Bank in 1978.<sup>14</sup> For both low-head (90 feet) and high-head (300 feet) applications, he compared Aermotor windmills with a Briggs & Stratton 4-horsepower, gasoline-powered, centrifugal pump, by using as his index the cost per 1,000 gallons of water delivered. Using a basic gasoline price of \$1 per US gallon, he drew up the analyses in Tables 6 and 7.

Steve's study was based on remote sites, particularly in Third World areas, where centrally distributed electricity was not available. In 1981, the costs of the windmill and the gasoline pump increased by approximately 8 to 10 percent, but the cost of gasoline is at least 50 percent higher than in 1978. It is clear that windmills are decidedly more economical in remote sites where intermittent supply is tolerable and purchasing capital is available. Steve concludes his analysis by mentioning that in larger applications, the cost/benefit ratio for gasoline or diesel pumps improves greatly. This improvement, he indicates, is due largely to the fact that the large pumps are water cooled and thus have a longer lifespan.

A more recent cost comparison, and one that is more in line with the typical rural or suburban

14. S. Blake, "Wind-Driven Water Pumps; Economics, Technology, Current Activities," (The World Bank, 1818 H Street, N.W., Washington, D.C.), 1978.

**Table 6. Cost Comparison for Windmill Versus Conventionally Fueled Pump — Low-Head Application**

Head: 90 feet (5-foot suction)  
Demand: 50,000 to 100,000 U.S. gallons per month

	WINDMILL		GASOLINE ENGINE	
Manufacturer, type	Aermotor, 6-foot diameter, 40-foot tower		Briggs & Stratton, 4 hp, 3,600 rpm, Model 80200, air-cooled	
Pump	Positive displacement, single action 2-inch diameter		Centrifugal, suction	
System life	30 yr		100 to 500 hr	
Pumping capacity (at mean wind speeds)	10 mph - 80 g/hr (21 x 10 <sup>6</sup> g/30 yr) 12 mph - 104 g/hr (26 x 10 <sup>6</sup> g/30 yr) 15 mph - 130 g/hr (34 x 10 <sup>6</sup> g/30 yr)		1,200 g/hr 600,000 g/500 hr	
Lifetime system cost	Equipment	\$1,630	Engine	\$115
	Installation	600	Pump	85
	Operation and maintenance, 1%/yr	669	Operation and maintenance	30
	Interest*	1,698	Interest, * 1 yr	20
			Fuel, 0.25 g/hr	
			@ .625 load; 500 hr; \$1/g	125
	Total	4,597	Total	375
Cost per 1,000 gallons of water delivered	\$0.22 U.S. (10 mph) 0.18 U.S. (12 mph) 0.14 U.S. (15 mph)		\$0.63 U.S.	

\*Interest computed at 10 percent, compounded monthly, over 10 years

Source: Blake, Steve, "Wind Driven Water Pumps," The World Bank, 1818 M St., NW, Wash. D.C. December, 1978.

**Table 7. Cost Comparison for Windmill Versus Conventionally Fueled Pump — High-Head Application**

Head: 300 feet

Demand: 90,000 to 150,000 US gallons per month

	<b>WINDMILL</b>		<b>GASOLINE ENGINE</b>	
Manufacturer, type	Aermotor, 12-foot diameter, 40-foot tower		Briggs & Stratton, 4 hp, 3600 rpm, Model 80200, air-cooled	
Pump	Positive displacement, single action, 2-inch diameter		Dempster Model 76 reciprocating pump coupled to a positive displacement, single action, 2-inch diameter cylinder	
System life	30 yr		100 to 500 hr	
Pumping capacity (at mean wind speeds)	10 mph - 128 g/hr (34 x 10 <sup>6</sup> g/30 yr) 12 mph - 165 g/hr (43 x 10 <sup>6</sup> g/30 yr) 15 mph - 206 g/hr (54 x 10 <sup>6</sup> g/30 yr)		220 g/hr 110,000 g/500 hr	
Lifetime system cost	Equipment	\$3,950	Engine	\$115
	Installation	800	Pump	750
	Operation and maintenance, 1%/yr	1,425	Operation and maintenance	30
	Interest*	3,617	Interest*, 1 yr	87
	Total	<u>9,892</u>	Fuel, 0.25 g/hr @ .625 load; 500 hr; \$1/g	125
			Total	<u>1,107</u>
Cost per 1,000 gallons of water delivered	\$0.29 US (10 mph) 0.23 US (12 mph) 0.18 US (15 mph)		\$0.90 US	

\*Interest computed at 10 percent, compounded monthly, over 10 years.

Source: Blake, Steve, 1978

domestic application was conducted by Joe Carter for *Wind Power Digest* in 1979.<sup>15</sup> Joe did a rough analysis of a commercial windmill versus an electric submersible pump. He calculated in operational and parts replacement costs for both pumps over a twenty-year period and found that the windmill and electric pump cost the same in the twentieth year. In other words, each year that the windmill pumped beyond the twentieth year was a profit for the windmill owner.

Here on Cape Cod, we performed an analysis of a client's home in 1980. The site was a good one, with an average of 10-mph winds evenly distributed throughout the year. The job in this case was not a small one; our client needed 800 to 1,000 gallons per day and was unwilling to accept less than 25 psi pressure at his upstairs shower, 20 feet above the well head. Adding in the 75-foot well and friction losses, we calculated a total required head of 200 feet. Using the commercial windmill performance charts, (and being exceedingly conservative, for safety's sake) we calculated that a 10-foot windmill on 30-foot tower, with a 1 $\frac{7}{8}$ -inch pump cylinder would do the job. The complete cost of this windmill and tower, shipped and installed, came to about \$3,200. Incidentally, and as Joe Carter aptly points out, we found that if water demand had been cut in half

15. Joe Carter, "Using Water-Pumping Windmills: Part I," *Wind Power Digest* 14(Winter, 1978):24-34.

to 400 to 500 gallons per day, the windmill system's cost would be about \$2,500 (\$700 less!).

The electric submersible pump which was recommended by our local supplier for this job was a  $\frac{3}{4}$ -horsepower 9-amp, 220-volt machine, rated at an average 10 gallon-per-minute capacity. Following Joe Carter's example, we asked our submersible pump dealer to help us analyze the cost of the submersible over twenty years. Eventually (and after much haggling) he agreed that every six years, 50 percent of the submersible pump's original cost would have been re-invested in parts replacement and other maintenance to make it last over that period. This estimated "replacement cost" compares well with Joe's and others' experiences. The electricity costs for the pump were based on a rate of 5 cents per kilowatt-hour in year one, and an average 12 percent fuel cost inflation rate per year. In reality, this estimate turns out to be quite conservative. In the fall of 1980, electricity prices in our area rose over 50 percent in three months! There is no indication of even a leveling off of prices in the near future.

Putting all of this information together, we come up with the results on the following page.

So far, it looked like the windmill could be amortized between year 14 and year 20, depending on the owner's ability to cut his or her water usage. However, we weren't done yet. It turns out that the U.S. government offers an

## TWENTY YEAR COST ANALYSIS

	<u>Electric Submersible Pump</u>			<u>Commercial Water-Pumping Windmill</u>		
	<u>Year 6</u>	<u>Year 12</u>	<u>Year 18</u>	<u>Standard</u>	<u>With Water Conservation</u>	
Pump, box, installation	\$ 900.	\$ 900.	\$ 900.	\$3,200.	\$2,500.	
Replacement cost	450.	900.	1,350.	Operation & Maintenance*	640.	500.
Electricity	<u>296.</u>	<u>896.</u>	<u>1,418.</u>			
Total cost	<b>\$1,646.</b>	<b>\$2,696.</b>	<b>\$3,668.</b>	<b>\$3,840.</b>	<b>\$3,000.</b>	

\*Operation and maintenance rated at 1 percent per year x 20 years.

excellent incentive in the form of a federal energy tax credit of 40 percent against the up-front cost of a home wind energy system. This credit can be spread over a number of years until 1986, in case your annual income does not allow you to take advantage in the first year. And, as if this is not enough, some states including Colorado, Oregon,

and Massachusetts offer their own state credits on top of the federal allotment. In Massachusetts, our client had available a 40 percent federal tax credit on the first \$10,000 invested and a 35 percent State tax credit on the remainder. Thus, the real cost of the water pumping windmill was:

	<b>Standard</b>	<b>With Water Conservation</b>
Original cost	\$3,200	\$2,500
With 40 percent tax credit	\$1,920 + 640 (oper. & maint.) = \$2,560	\$1,500 + 500 (oper. & maint.) = \$2,000
With the state credit	\$1,248 + 640 (oper. & maint.) = \$1,888	\$ 975 + 500 (oper. & maint.) = \$1,475

Thus, we can now see a totally different picture thanks to Uncle Sam. With the 40 percent tax credit and no conservation, our client could pay back his system in less than twelve years! And, since he is in Massachusetts, he actually can achieve a payback in the eighth year! And let's not forget conservation; a thorough conservation effort including shower head restrictors, toilet flush dams, and nighttime garden watering results in a windmill system which he pays back in the fifth year!

And convinced he was. Not only is there a beautiful water-pumping windmill turning gently above our client's house, but he's now looking into an AC wind generator for his home electricity supply. But we'll save that discussion for another book. Before we conclude this chapter, let's now look at the cost of Samuel's and Barbara's sites (described in Chapter 3) in light of what we now know.

### **COST ANALYSES OF SAMUEL'S AND BARBARA'S SITES**

I do not have cost estimates for a comparable electric pump system at Samuel's site. However, my local submersible pump dealer has advised me that the cost would not vary greatly from the previous Cape Cod example. Consider, then the breakdown of Samuel's system costs (Table 8) versus the electric pump cost summary just presented. Thus, even with an annual \$51 operation and maintenance cost, Samuel's system can be

amortized against an electric pump in the fourteenth year. That, combined with the added security of a nearly foolproof fire protection system makes for a very reasonable investment.

Table 9 is a breakdown of costs for Barbara's system. Since Barbara will still keep her conventional system as a backup, she can only amortize this system in terms of electricity and pump deterioration saved. On this basis, her payback period is conservatively placed at eight years.

Economic justification of your WPWS will depend on a great many factors. In most cases, capital availability or your bank's current lending rate will play the most important role in your decision. Of equal importance in your decision will be the effect that a WPWS has on the resale value of your home, the neighbors' aesthetic preferences, and other such factors.

For those of you with a broader perspective, one that includes an appreciation of clean air and healthy biosphere, the benefits of owning your own windmill will far outweigh the costs. In the next twenty years, acid rain from midwestern coal burning is expected to kill 48,000 Northeastern North American lakes. The deleterious effects of burning oil for electricity generation have only begun to be measured, but even the most optimistic estimates project that available oil will be exhausted within thirty years. And even utilities in our region cannot find justification for building new nuclear power plants.

In the big cost-benefit analysis, the one that



measures the type of world we will leave for our grandchildren, windmills and other renewable energy devices are the only alternative. Enjoy your

**Table 8. Costs of Samuel's  
Water-Pumping Windmill System\***

10-foot windmill	\$1,745
60-foot tower and footings	2,000
1 $\frac{7}{8}$ -inch open-top pump cylinder and screen	130
$\frac{1}{2}$ -inch pump rod and couplings	35
Drop pipe and well seal	75
Packer head	60
Delivery pipe	270
Water tank	<u>250</u>
Total, parts	\$4,565
Installation/assembly	<u>500</u>
Total, installed windmill	\$5,065
Total, with 40% tax credit	\$3,039

\* All prices include shipping costs.

windmilling, and be proud of yourself. You've invested in the one future that makes any sense at all.

**Table 9. Costs of Barbara's  
Water-Pumping Windmill System\***

10-foot windmill	\$ 995
50-foot tower and footings	1,760
2 $\frac{1}{2}$ -inch closed-top pump cylinder and screen	103
$\frac{7}{16}$ -inch pump rod and couplings	14
Drop pipe and well seal	35
Packer head	50
Delivery pipe	15
Relief valve	13
3-inch cased well	<u>150</u>
Total, parts and well	\$3,135
Installation/assembly	<u>400</u>
Total	\$3,535
Total, with 61% tax credit	\$1,379

\* All prices include shipping costs.

## **Extra Appendix**

**Extract from - An Urban & Rural Demonstration of a Wind-powered Water Pump.**

**DOE Report by NAI - USA 1982**

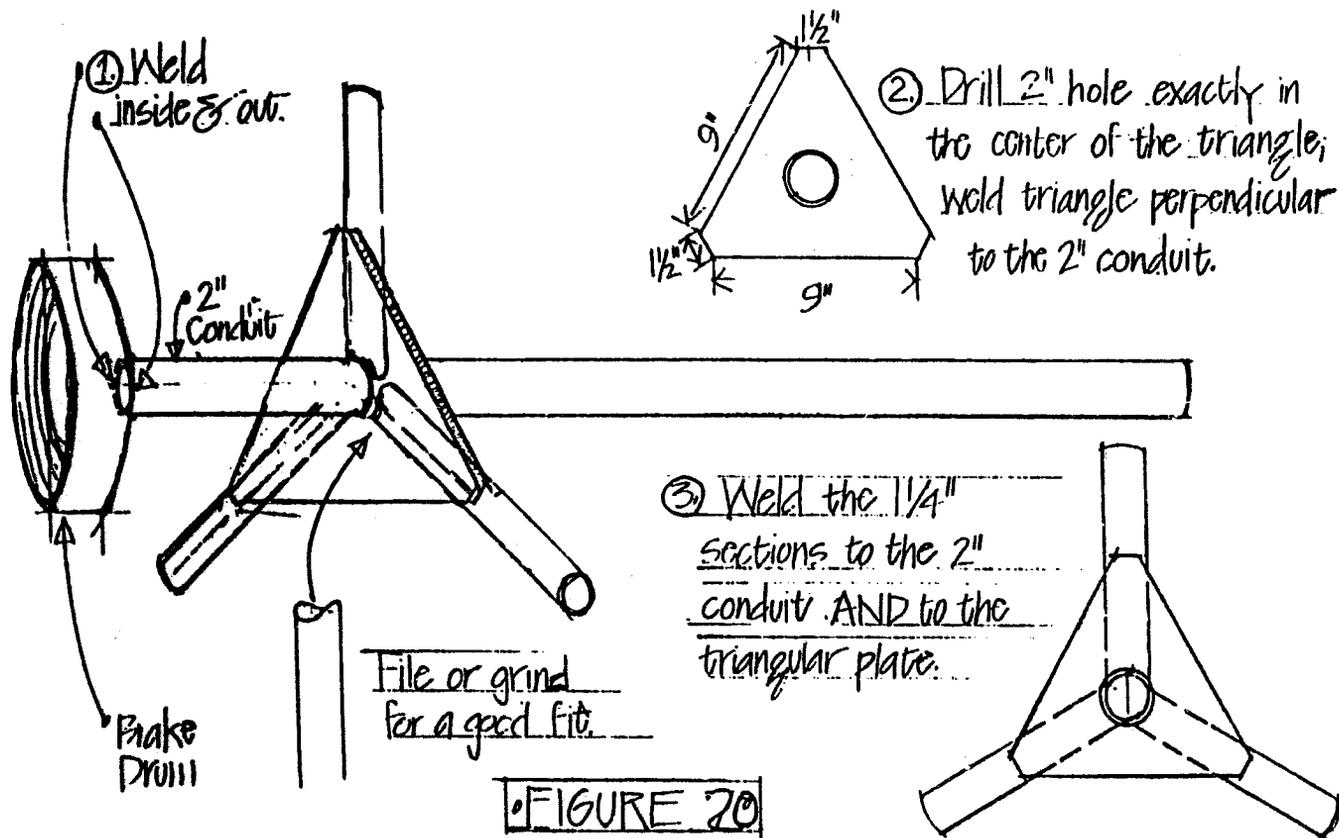

Position of the Used Automobile brake on the Sailing Rotor

### 3. The Brake.

The original Sailwing prototype did not have a brake. The operator of this experimental machine had to manually stop the rotor from mid-tower when furling or inspecting the machine. Two braking strategies were designed in this project, but only one is ready for wide-scale application.

The first, a manual turn-out lever, has performed beautifully on the Boston mill and on a Sailwing which we constructed in Yoro, Honduras, in January, 1981. The operator manually yaws the rotor out of the wind while standing at a position inside the tower and below the bottom on the wind rotor's stroke. Once the rotor is yawed parallel to the wind, it comes to a halt and the operator can manually furl the sails from the same spot. We are very pleased with this strategy and have found that it can be easily understood and performed by laypersons with no prior windmill experience.

The second strategy involves the use of a used rear wheel automotive brake (see Figure 4). The operator engages the brake from ground level and two 300 ft-lb springs bring the rotor to a stop in gusts of up to 28 mph. However, the brake and springs must be re-set on the tower top, and while we did construct a simple re-set lever, we are not satisfied with this potentially hazardous solution.

For the time being, the manual turn-out lever can be recommended as a safe, simple and effective braking strategy.

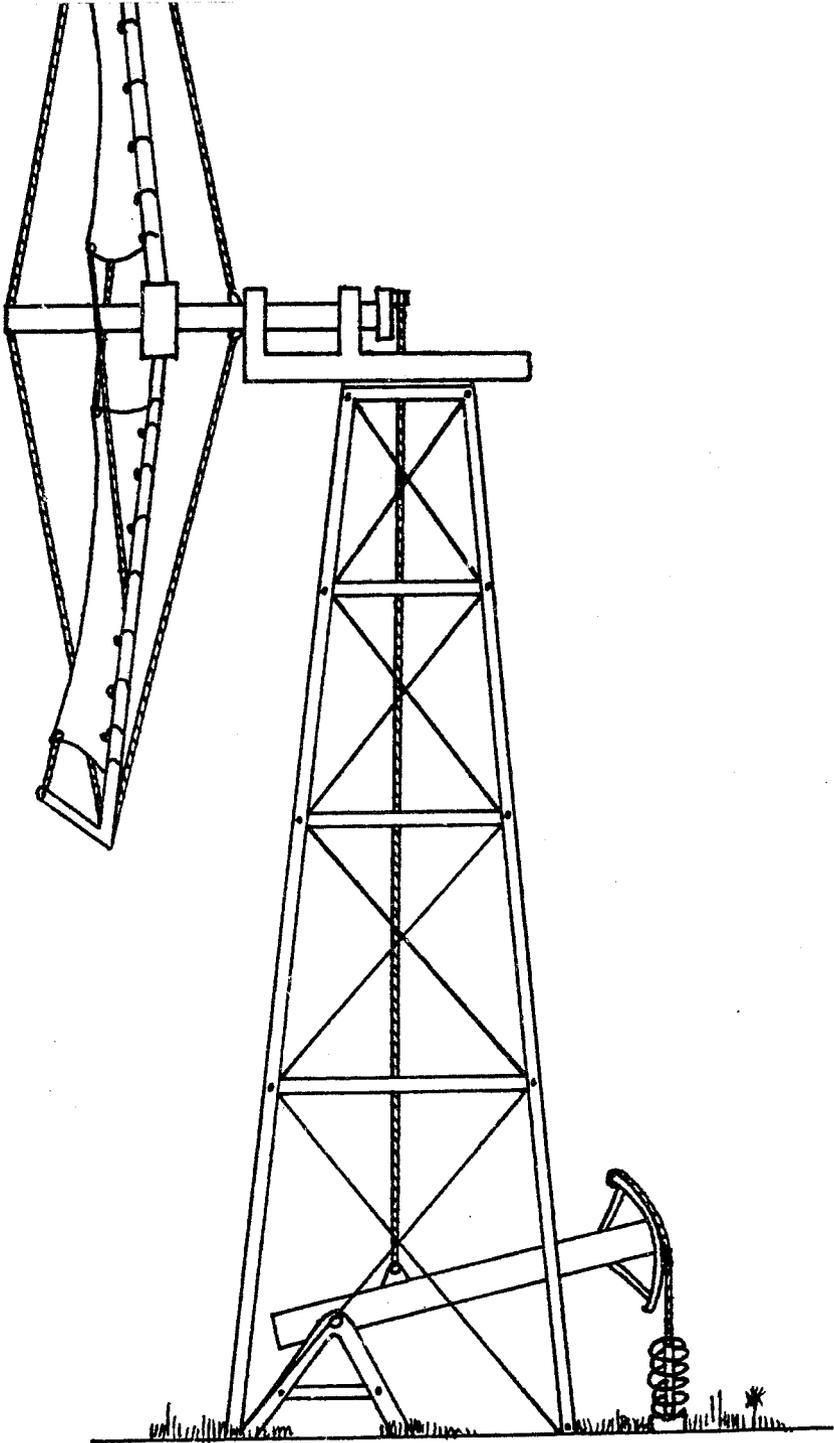

Figure 6 Schematic of cost-saving pump lever arm under construction at Cape Cod Sailing

This windmill is largely the same as that described in Appendix 1, with three exceptions. First, as described in Phase 1 of this report, we have experimented with a used automobile emergency brake from a 1969 Plymouth Duster. We are not yet satisfied with this design and will continue to experiment during the summer of 1981.

Secondly, as part of our efforts to make wind-powered water-pumping as economical as possible, we have attempted an innovative pump configuration which could reduce the overall system's cost by 40 %. This cost reduction is achieved primarily through savings in the cost of the well.

A windmill's performance and pumping capacity is directly related to the water volume capacity of the submerged positive displacement pump cylinder. For a windmill with a known stroke length, one can calculate the appropriate diameter cylinder for any particular pumping application. Accordingly, commercial pump cylinders can be purchased off-the-shelf in sizes ranging from 1 7/8-in diameter to 4-in in barrel diameter.

However, one cost consideration which the pump manufacturers tend not to mention is the exponentially rising cost per foot for increasing

well diameters needed to accommodate larger pump cylinders. For instance, on Cape Cod a 3-in diameter cased well costs \$8.00/ft to install. The next available size in our region, a 6-in cased well, costs \$26.00/ft installed! What this means for a prospective windmill is that a pump larger than 2½-in diameter requires a well that costs more than three times greater than the next smaller available size.

Our calculations indicated that our mill would be able to pump more than the load of a 2½-in pump with a 7-in stroke. Faced with the dilemma of paying the cost of a larger well, we opted to increase the windmill's stroke by an on-the-ground lever arm mounted adjacent to the well.

The prototype apparatus is described in Figure 6. A 52-ft by 3-in cased and developed well was installed off-set from the center of the windmill tower. The lever arm (still under construction) is designed to operate by cable and weights from the windmill rotor and to connect to the polish rod in a manner that is similar to that of a commercial pump jack or oil field pump. We expect to achieve a stroke increase of 2.5X with this system.

## Appendix

# Useful Resources

### *Water-Pumping Windmill Companies*

#### **Aermotor**

Division of Valley Industries  
P.O. Box 1364  
Conway, AR 72032

#### **Baker**

The Heller-Aller Company  
Perry and Oakwood Streets  
Napoleon, OH 43545  
(419) 592-1856

#### **Bowjon**

The Bowjon Company  
2829 Burton Avenue  
Burbank, CA 91504

#### **Dempster**

Dempster Industries Inc.  
P.O. Box 848  
Beatrice, NB 68310  
(402) 223-4026

#### **The Mishler Company**

Beverly, KS 67423

(913) 436-2365

#### **SPARCO**

Distributed by Enertech  
P.O. Box 420  
Norwich, VT 05055  
(802) 649-1145

### *Other Home-Built (Indigenous) Windmill Plans*

#### *The Arusha Windmill: A Construction Manual* (\$3.75)

Volunteers In Technical Assistance (VITA)  
3706 Rhode Island Avenue  
Mt. Rainier, MD 20800

#### **Intermediate Technology Development Group (ITDG)**

9 King St.  
London WC2E 8HN, United Kingdom

#### *The Polomo Windmill:*

*Food from Windmills* (by Peter Frankel, 1975)  
Available from Intermediate Technology Publication, Ltd.  
9 King St.,  
London WC2E 8HN, United Kingdom

***Homemade Windmills of Nebraska***

(by Erwin Hinckley Barbour, 1899)

Available from The Farallones Institute  
Occidental, CA 95465

***Do-It-Yourself Sail Windmill*** (Cretan) *Plans*

National Center for Alternative Technology  
Machynlleth, Powys,  
Wales, U.K.

***The Gaudgaon Sailing Windmill***

(by W.W. Smith, III)

P.O. Box 281  
Jamestown, RI 02835

***Low-Cost Windmill for Developing Nations***

(by Hartmut Bossel, 1977)

Available from VITA

***Savonius Wind Pumps***

**International Rice Research Institute (IRRI)**

P.O. Box 933  
Manila, Philippines

**Brace Research Institute**

MacDonald College of McGill University  
Ste Anne De Belevue 800  
Montreal, Quebec, Canada

***Windmill Access Catalogue***

***Wind Power Digest***

54468 CR 31  
Bristol, IN 46507

***Windmill Association***

**American Wind Energy Association**

1609 Connecticut Avenue, N.W.  
Washington, DC 20009

***Windmill Course***

**New Mexico State University**  
Agricultural & Extension Education  
P.O. Box 3501  
Las Cruces, NM 88003

***Windmill Museums***

**The Windfarm Museum**

RFD, Vineyard Haven, MA 02568

**The Panhandle Plains Historical Museum**

T. Lindsay Baker, Curator  
P.O. Box 967, W.T. Station  
Canyon, TX 79016

***Windmill Photographs/Slides***

Available from

**Gary Emerson**

750 South 41 St.  
Boulder, CO 80303

***Windmill Journals***

***Alternative Sources of Energy*** (Bimonthly)

Rt. 2  
Milaca, MN 56353

***Wind Power Digest*** (Quarterly)

54468 CR 31  
Bristol, IN 46507

***Wind Technology Journal***

P.O. Box 7  
Marstons Mills, MA 02648

***Anemometers***

The following companies market anemometers and  
recording devices:



**Aeolian Kinetic**  
P.O. Box 100  
Providence, RI 02901  
(401) 421-5033

**Bendix Environmental and  
Process Instruments Division**  
1400 Taylor Avenue  
Baltimore, MD 21204  
(301) 321-5200

**Dwyer Instruments, Inc.**  
P.O. Box 373  
Michigan City, IN 46360  
(219) 872-9141

**Meteorology Research, Inc.**  
P.O. Box 637  
Altadena, CA 91001  
(213) 791-1901

**Natural Power, Inc.**  
Francestown Turnpike  
New Boston, NH 03070  
(603) 487-5512

**Sign X Laboratories, Inc.**  
Stetson Road  
Brooklyn, CT 06234  
(203) 774-5233

**M.C. Stewart**  
Ashburnham, MA 01430  
(617) 827-5840

**Taylor Instruments**  
P.O. Box 1  
Arden, NC 28704  
(704) 684-8111

**Weather Measure Corporation**  
P.O. Box 41257

Sacramento, CA 95841  
(916) 481-7565

*Other WPWS Components:*

Pumps, Cylinders, Packer Heads, etc.

**Clayton Mark**  
Division of Mark Controls Corporation  
143 E. Main St.  
Lake Zurich, IL 60047  
(312) 438-2303

**Midwest Well Supply Co.**  
P.O. Box 547, 11213 Dundee Road  
Huntley, IL 60142

**Midland Mfg. Co.**  
2550 West Vickery Blvd.  
Fort Worth, TX 76101  
(817) 332-4403

**Jensen Brothers Mfg. Co., Inc.**  
4th & Pacific Streets  
Coffeyville, KS 67337  
(316) 251-5700

*Water Wells*

*Water Well Manual* (by Ulrich P. Gibson and Rexford D. Singer, 1977)

Available from  
Premier Press  
P.O. Box 4428  
Berkeley, CA 94704

**Construction and Maintenance of Water Wells** (1979)  
Available from VITA

*The Village Technology Handbook* (1977)  
Available from VITA

***Water Systems Handbook*** (1977)

Available from

Water Systems Council

221 North LaSalle St.

Chicago, IL 60601

***Ground Water and Wells***

Available from

Edward E. Johnson, Inc.

St. Paul, MN 55104

Library of Congress #6629629

***Additional Information***

Siting

***Siting Handbook for Small Wind Energy Systems***

Aeolian Kinetics, P.O. Box 100; Providence, R.I. 02901

***A Siting Handbook for Small Wind Energy Conversion Systems***

H. Wegley, M. Orgill, and R. Drake, Order No. PNL-2521  
Battelle Pacific Northwest Laboratory, May 1978, 132 pp.,  
\$7.00. Available from NTIS.

***Index-Summarized Wind Data***

W.T. Changery, W.T. Hodge, and J.V. Ramsdell

BNWL-2220, WIND-11, Battelle Pacific Northwest Laboratory,  
Richland, WA 99352, 1977, 245 pp., \$9.50. Available  
from NTIS.

**National Climatic Center (NCCC)**

NOAA Environmental Data and Information Service,

Federal Building

Asheville, NC 28801

***Northwest Wind Energy Resource Assessment Atlas***

W.R. Barchet and D. Elliott

Battelle Pacific Northwest Laboratory, Richland, WA  
99352, 1979, 100 pp., \$6.00. Available from NTIS.

***Site Selection and Evaluation Handbook for Wind Energy Systems***

Steve Blake

Sunflower Power Company, Route 1, Box 93-A, Oskaloosa,  
KS 66066, May 1979, 60 pp., \$8.50 domestic, \$9.50  
foreign.

***Summary of Wind Data from Nuclear Power Plant Sites***

M.G. Vernolek

BNWL-2220, WIND-4, Battelle Pacific Northwest Laboratory,  
Richland, WA 99352, 1977, 342 pp., \$12.00.  
Available from NTIS.

*To order from NTIS contact:*

**National Technical Information Service**

U.S. Department of Commerce

5285 Port Royal Road

Springfield, VA 22161

(703) 557-4650

***Windmill Technical Reports***

DHV Consulting Engineers

P.O. Box 85

3800 AB Amersfoot — The Netherlands

***New Alchemy Sailing Components***

Sails:

**North Sails East**

305 Sniffens Lane

Stratford, CT 06497

(203) 375-5638

Bearings:

**Rotek, Inc.**

220 West Main Street

Ravenna, OH 44266

# Bibliography

- CLARK, W. 1974. *Energy for Survival*. Garden City, New York: Anchor Press/Doubleday.
- DREES, J.M. 1977. Blade Twist, Droop Snoot, and Forward Spars. *Wind Technology Journal* 1:10-16.
- ELDRIDGE, F.R. 1980. *Wind Machines*. 2d ed. New York: Van Nostrand Reinhold.
- GENERAL ELECTRIC. 1977. *Wind Energy Mission Analysis*. Available from National Technical Information Service (NTIS), U.S. Dept. of Commerce, Springfield, VA 22161.
- GIBSON, U.P., and SINGER, R.D. 1977. *Water Well Manual*. Berkeley, CA: Premier Press.
- HIRSHBERG, G. et al. 1977. The Way of Wind at New Alchemy Institute. *Wind Power Digest* 9:16-29.
- MARCHESINI, L., and POSTRA, S.F. 1978. *Cost Comparison of Windmill and Engine Pumps*. Available from Steering Committee on Wind Energy for Developing Countries, P.O. Box 85, Amersfoort, The Netherlands.
- MCDERMOTT, J. 1980. How to Make a Wind-Site Analysis. *Popular Science*, July, 1980:100-102.
- MCGUIGAN, D. 1978. *Harnessing the Wind for Home Energy*. Charlotte, Vermont: Garden Way Publishing.
- NEW MEXICO ENERGY INSTITUTE. 1979. *Selecting Water-Pumping Windmills*. Available from the Institute at P.O. Box 3E1, Las Cruces, New Mexico 88003.
- PARK, J. and SCHWIND, R. 1978. *Wind Power for Farms, Homes and Small Industry*. Available from NTIS.
- REYNOLDS, J. 1970. *Windmills and Watermills*. New York: Praeger Publishers.
- SHERMAN, M.M. 1977. *Practical Application of Wind Powered Water Pumps*. Economic and Social Commission for Asia and the Pacific, Natural Resources Division, Sala Santitham, Bangkok 2, Thailand.
- SOLAR ENERGY RESEARCH INSTITUTE. *Wind Energy Information Directory*. Available from the Institute at 1617 Cole Boulevard, Golden, CO 80401.
- STERN, P. 1979. *Small Scale Irrigation*. London: ITDG Publications, 9 King Street, London, UK.
- U.S. DEPARTMENT OF ENERGY. 1980. *Proceedings from the Fourth Wind Energy Workshop*. Arlington, VA: JBF Scientific Corp. Available from NTIS.
- VITA. 1979. *Construction and Maintenance of Water Wells*. Available from VITA, 3706 Rhode Island Ave., Mt. Rainier, MD 20822.

# Notes

1. USDA estimate. Personal communication with Professor M.I. Rasmussen, New Mexico State University, Las Cruces, New Mexico 88003.
2. Wilson Clark, *Energy for Survival* (New York: Anchor Books, 1975), p. 524.
3. Clark, p. 519.
4. Clark, p. 520.
5. Jan M. Drees, "Blade Twist, Droop Snoot, and Forward Spars," *Wind Technology Journal* 1(Spring, 1977): 10-16.
6. Clark, p. 521.
7. "Selecting Water-Pumping Windmills," (New Mexico Energy Institute, P.O. Box 3EI, Las Cruces, New Mexico 88003), p. 1.
8. S. Buning, "Greasing the Windmill," *Dialogue* (Grand Rapids, Michigan: Calvin College, 1978).
9. Clark, p. 522.
10. Marcus Sherman, "A Windmill in India," *The Journal of the New Alchemists* 1(1974):15-17.
11. G. Hirshberg et al., "Wind and Solar at New Alchemy," *Wind Power Digest* 11(1977-78):16-25.
12. Ron Zweig, "Three Experiments with Semi-Closed Fish Culture Systems," *The Journal of the New Alchemists* 4(1977):69-77.
13. T. Cashman, "The Green Gulch Sailing," *The Journal of The New Alchemists* 5(1979):37-43.
14. S. Blake, "Wind-Driven Water Pumps; Economics, Technology, Current Activities," (The World Bank, 1818 H Street, N.W., Washington, D.C., 1978).
15. Joe Carter, "Using Water-Pumping Windmills: Part I," *Wind Power Digest* 14(Winter, 1978):24-34.

# About The New Alchemy Institute

THE NEW ALCHEMY INSTITUTE IS A SMALL, NONPROFIT ORGANIZATION with over eleven years of experience in the research and education of renewable resource technologies. Our goal has been to design and test human support systems — food, energy, shelter — that are environmentally sound and economically efficient. We favor strategies that minimize reliance on fossil fuels and that operate on an economic scale accessible to families and small enterprises.

Our Cape Cod Center is comprised of twenty-two (more or less) full-time researchers, educators, designers, and craftspeople. Many of us devote part of each year to working in other parts of the world, including our Costa Rica Center (NAISA). Our international work is carried out in the hope that our research and our experience can be used by large numbers of people in diverse regions of the world.

Our first decade of work has focused largely on the research and development of technologies that support low-cost, year-round food production and energy-efficient shelter design. Our work in biological agriculture, wind technology, and solar design is well known and has been supported by the *U.S. Departments of Energy and Agriculture*, the *Environmental Protection Agency*, the *Solar Energy Research Institute*, the *National Science Foundation*, and a broad

range of private foundations. Our solar aquaculture research is widely reported in the U.S. and international scientific literature and has been the focus of visits by senior scientists and dignitaries from all parts of the globe.

Perhaps the most dramatic aspect of our work has been the integration of these sciences, as in our bioshelters. Bioshelters are solar-heated buildings that link a variety of biological elements in new, productive ecosystems. We were among the first to develop solar greenhouses that incorporated both aquaculture and agriculture.

Our small, twelve-acre Cape Cod Center has been visited by over a hundred thousand people. Recently, the Institute has been pressed to provide comprehensive technical information to large numbers of energy-conscious regional, national, and international constituents. We have responded by broadening our research focus to include an extensive agenda of outreach and educational activities. In addition to our summer Saturday workshop program (over 7000 visitors in 1980), we now run a year-round group tour program which serves over 5,000 students and senior citizens annually. This summer, our first series of full-day specialty courses was a booming success, receiving several hundred more applicants than we could accommodate. Our apprenticeship program serves approximately forty people each year.

The decade ahead will be a difficult one. Fuel costs continue to rise as fossil fuel reserves

dwindle. Each day we are reminded of serious new toxic threats to the environment and to human health. The New Alchemy Institute is convinced of an urgent need to create new support systems that are inexpensive, productive, and environmentally sustainable.

The Institute is nonprofit and tax-exempt and derives its support from private contributions and research grants. Grants for the scientific research are usually available, but adequate funding for general support remains uncertain. The success of the Institute will depend on our ability to address ourselves to the genuine needs of people working on behalf of themselves and the earth, and on the realization by our friends that financial support of our research is essential if the task ahead is to be accomplished.

The New Alchemy Institute has an Associate Membership (\$35.00 per annum, tax-deductible) which is available to those interested in helping support our work. Upon joining, Associates receive the current annual *Journal of the New Alchemists*. Newsletters and other special interest mailings sent throughout the year keep Associates further informed of the work in progress. Over the years, the support of our Associates has been critical to the continuance of the Institute and its work.

Associate Membership  
for Individuals and Families . . . \$35 per annum

Contributions of larger amounts are very much needed, and appreciated.

Contributing Membership . . . . .	\$ 50 per annum
Sustaining Membership . . . . .	\$ 100 per annum
Sponsor . . . . .	\$ 250 per annum
Patron . . . . .	\$ 500 per annum
Life Membership . . . . .	\$1,000

Friends wishing to have their membership payments qualify as a deductible contribution under the tax regulations of Canada should make Canadian dollar payments payable to The New Alchemy Institute (P.E.I.) Inc. All other membership contributions should be made payable to The New Alchemy Institute. Because of the costs involved with collection charges and currency exchange, we ask that all payments to The New

Alchemy Institute, except for Canadian membership, be in the form of United States dollar instruments, preferably International Money Orders.

We invite you to join us as members of The New Alchemy Institute. A company of individuals addressing themselves to the future can, perhaps, make a difference during these years when there is waning reason to have hope in the continuance of human history.

Gary Hirshberg  
 Executive Director  
 The New Alchemy Institute  
 237 Hatchville Road  
 East Falmouth, Massachusetts 02536